

ALLEN & HEATH

GLSERIES



GL2400

USER GUIDE

Publication AP5597

Limited One Year Warranty

This product is warranted to be free from defects in materials or workmanship for a period of one year from the date of purchase by the original owner.

To ensure a high level of performance and reliability for which this equipment has been designed and manufactured, read this User Guide before operating. In the event of a failure, notify and return the defective unit to Allen & Heath Limited or its authorised agent as soon as possible for repair under warranty subject to the following conditions

Conditions Of Warranty

1. The equipment has been installed and operated in accordance with the instructions in this User Guide
2. The equipment has not been subject to misuse either intended or accidental, neglect, or alteration other than as described in the User Guide or Service Manual, or approved by Allen & Heath.
3. Any necessary adjustment, alteration or repair has been carried out by Allen & Heath or its authorised agent.
4. This warranty does not cover fader wear and tear.
5. The defective unit is to be returned carriage prepaid to Allen & Heath or its authorised agent with proof of purchase.
6. Units returned should be packed to avoid transit damage.

In certain territories the terms may vary. Check with your Allen & Heath agent for any additional warranty which may apply.



This product complies with the European Electromagnetic Compatibility directives 89/336/EEC & 92/31/EEC and the European Low Voltage Directives 73/23/EEC & 93/68/EEC.

This product has been tested to EN55103 Parts 1 & 2 1996 for use in Environments E1, E2, E3, and E4 to demonstrate compliance with the protection requirements in the European EMC directive 89/336/EEC. During some tests the specified performance figures of the product were affected. This is considered permissible and the product has been passed as acceptable for its intended use. Allen & Heath has a strict policy of ensuring all products are tested to the latest safety and EMC standards. Customers requiring more information about EMC and safety issues can contact Allen & Heath.

NOTE: Any changes or modifications to the console not approved by Allen & Heath could void the compliance of the console and therefore the user's authority to operate it.

GL2400 User Guide AP5597 Issue 2

Copyright © 2005 Allen & Heath Limited. All rights reserved

Allen & Heath Limited

Kernick Industrial Estate, Penryn, Cornwall, TR10 9LU, UK
<http://www.allen-heath.com>

Important Safety Instructions

WARNINGS - Read the following before proceeding :

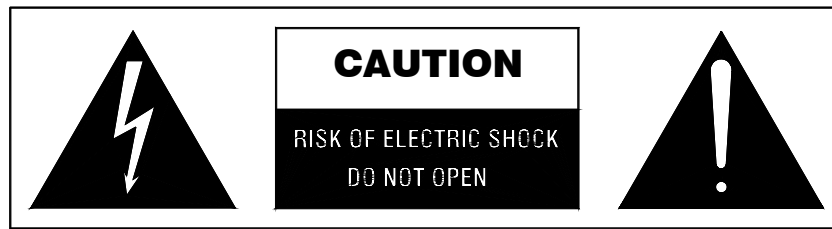

ATTENTION: RISQUE DE CHOC ELECTRIQUE – NE PAS OUVRIR

Read instructions: Read and retain these safety and operating instructions for future reference. Adhere to all warnings printed here and on the console. Follow the operating instructions printed in this User Guide.

Do not remove cover: Operate the console with its underside cover correctly fitted. Disconnect mains power by unplugging the power cord if the cover needs to be removed for setting internal options. Refer this work to competent technical personnel only.

Power sources: Connect the console to a mains power outlet only of the type described in this User Guide and marked on the rear panel. Use the power cord with sealed mains plug appropriate for your local mains supply as provided with the console. If the provided plug does not fit into your outlet consult your service agent for assistance.

Power cord routing: Route the power cord so that it is not likely to be walked on, stretched or pinched by items placed upon or against it.

Grounding: Do not defeat the grounding and polarisation means of the power cord plug. Do not remove or tamper with the ground connection in the power cord.



WARNING: This equipment must be earthed.

Water and moisture: To reduce the risk of fire or electric shock do not expose the console to rain or moisture or use it in damp or wet conditions. Do not place containers of liquids on it which might spill into any openings.

Ventilation: Do not obstruct the rear and top ventilation slots or position the console where the air flow required for ventilation is impeded. If the console is to be operated in a flight case, plinth or other furniture ensure that it is constructed to allow adequate ventilation.

Heat and vibration: Do not locate the console in a place subject to excessive heat or direct sunlight as this could be a fire hazard. Locate the console away from any equipment which produces heat or causes excessive vibration.

Servicing: Switch off the equipment and unplug the power cord immediately if it is exposed to moisture, spilled liquid, objects fallen into the openings, the power cord or plug become damaged, during lightning storms, or if smoke, odour or noise is noticed. Refer servicing to qualified technical personnel only.

Installation: Install the console in accordance with the instructions printed in this User Guide. Do not connect the output of power amplifiers directly to the console. Use audio connectors and plugs only for their intended purpose.

General Precautions

Damage To prevent damage to the controls and cosmetics avoid placing heavy objects on the control surface, scratching the surface with sharp objects, or rough handling and vibration.

Environment Protect from excessive dirt, dust, heat and vibration when operating and storing. Avoid tobacco ash, smoke, drinks spillage, and exposure to rain and moisture. If the console becomes wet, switch off and remove mains power immediately. Allow to dry out thoroughly before using again.

Cleaning Avoid the use of chemicals, abrasives or solvents. The control panel is best cleaned with a soft brush and dry lint-free cloth. The faders, switches and potentiometers are lubricated for life. The use of electrical lubricants on these parts is not recommended. The fader and potentiometer knobs may be removed for cleaning with a warm soapy solution. Rinse and allow to dry fully before refitting them.

Lifting To avoid injury to yourself or damage to the equipment take care when lifting, moving or carrying the console.

Transporting The console may be transported as a free-standing unit or mounted in a purpose built flight case. We recommend that the console is surrounded by shock absorbent foam to protect it from damage during transit. Always use adequate packing if you need to ship the unit. Protect the controls to avoid damage when moving the console.

Hearing To avoid damage to your hearing do not operate any sound system at excessively high volume. This also applies to any close-to-ear monitoring such as headphones and IEM transducers. Continued exposure to high volume sound can cause frequency selective or wide range hearing loss.



Important Mains plug wiring instructions.

The console is supplied with a moulded mains plug fitted to the AC mains power lead. Follow the instructions below if the mains plug has to be replaced. The wires in the mains lead are coloured in accordance with the following code:

TERMINAL		WIRE COLOUR	
		European	USA/Canada
L	LIVE	BROWN	BLACK
N	NEUTRAL	BLUE	WHITE
E	EARTH GND	GREEN & YELLOW	GREEN

The wire which is coloured Green and Yellow must be connected to the terminal in the plug which is marked with the letter E or with the Earth symbol. **This appliance must be earthed.**

The wire which is coloured Blue must be connected to the terminal in the plug which is marked with the letter N.

The wire which is coloured Brown must be connected to the terminal in the plug which is marked with the letter L.

Ensure that these colour codes are followed carefully in the event of the plug being changed.

Introduction

Welcome to the Allen & Heath **GL2400**, the latest generation of the popular GL series of dual function live sound mixing consoles. We have tried to keep this user guide brief and to the point. Please read it fully before starting. Included is information on installing, connecting and operating the console, panel drawings, system block diagram and technical specification. For further information on the basic principles of audio system engineering, please refer to one of the specialist publications and resources available from bookshops, audio equipment dealers and the Internet.

Whilst we believe the information in this guide to be reliable we do not assume responsibility for inaccuracies. We also reserve the right to make changes in the interest of further product development.

We are able to offer further product support through our world-wide network of approved dealers and service agents. You can also access our Web site on the Internet for information on our full product range, resource downloads, our company pedigree, contact details, assistance with your technical queries, or simply to chat about audio. To help us provide the most efficient service please keep a record of your console serial number, and date and place of purchase to be quoted in any communication regarding this product.

<http://www.allen-heath.com>

Contents

Gain Structure.....	23	Warranty.....	2
Using the Oscillator / Noise Generator	24	Important Safety Instructions	3
Mixing with Faders or Gain Controls.....	24	General Precautions	4
Using PFL / AFL.....	25	Introduction to this Guide.....	5
The dB.....	25	Panel Layouts	6
Using Inserts	25	Introducing the GL2400	8
Polarity	26	Installing the Console	10
Mixing the PA in Mono or Stereo?	26	Connecting Power	11
Zero the console.....	26	Audio Connections	13
Turning the System On or Off	26	The Console Connectors	14
Sound Levels	26	Mono Input Channel.....	16
Dual Functionality	27	Stereo Input Channel.....	18
Applications for the Matrix.....	28	Group/Aux Masters.....	19
Create IEM Mixes with Ambience	29	Aux5-6, LRM Masters.....	20
Using the Matrix to Create a Recording.....	29	7x4 Matrix.....	21
Recording with the GL2400.....	29	Monitor, Talkback and Sig Gen	22
Pre/Post Fade Aux Settings	29	Applications and Operating Tips.....	23
Aux-Fed Subs	30	Specifications	32
Creating a Separate C Mix	30	System Block Diagram.....	34
Other M Output Applications.....	30	User Options.....	35
Using the Channel Direct Outputs	31	Cue Sheet	38
Using the Stereo Channels	31		
A Note about Combining Signals	31		

GL2400

Channel 13, 14, 15, 16 control panel details.

Main control panel details for channels 1-4, L, R, and M.

The Range:

GL2400-16	14 mono mic/line, 2 mic/dual stereo
GL2400-24	22 mono mic/line, 2 mic/dual stereo
GL2400-32	30 mono mic/line, 2 mic/dual stereo
GL2400-40	38 mono mic/line, 2 mic/dual stereo
RPS 1 1	External power supply for the GL2400-40
MPS12	Backup power supply for the 16,24,32 frame sizes
GL2400-SLV2	Sys-Link V2 console in/out expander option kit

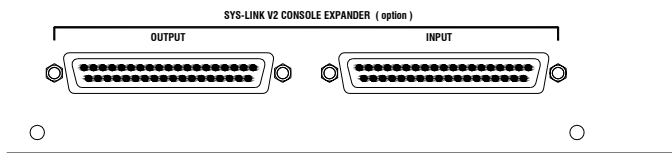
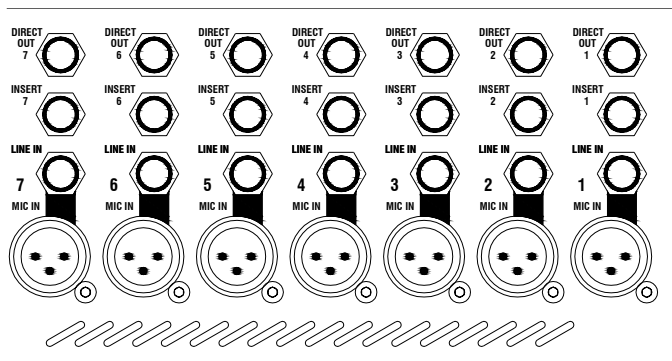
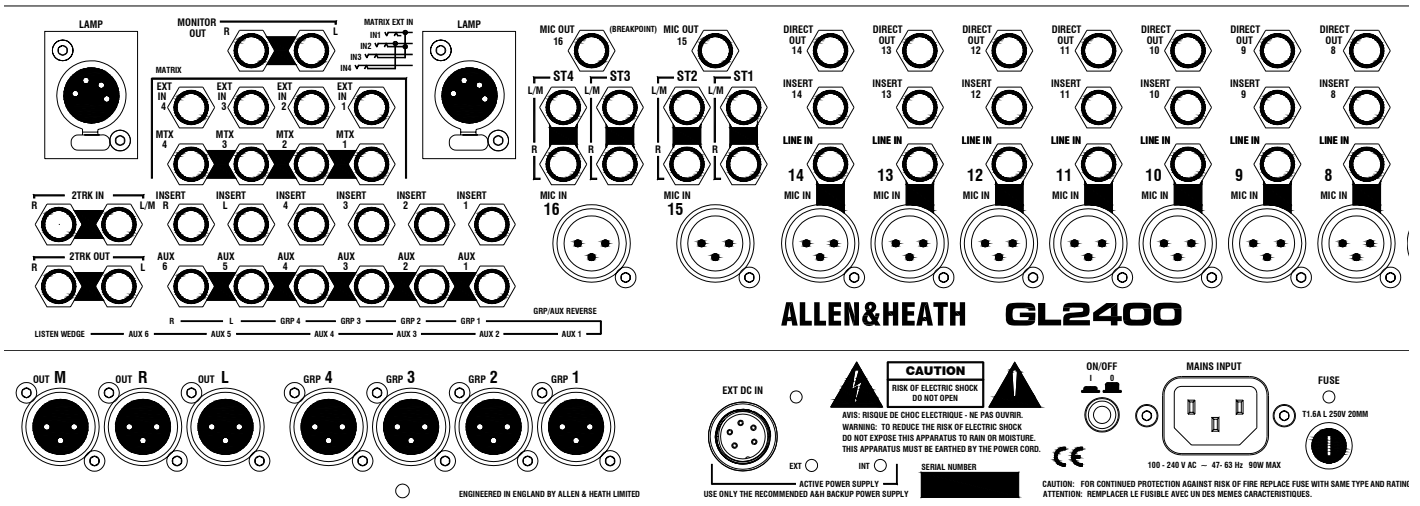

Introducing the Allen & Heath **GL2400**

The **GL2400** is a 4-bus dual function analogue mixing console designed for professional audio applications. Whether mixing FOH, monitors or both, recording live or in the studio, installed in a busy venue, out on the road touring, or earning its keep in rental stock, the **GL2400** provides the perfect solution. Engineered to the same exacting standards as our top of the range consoles it ensures the highest reliability and finest sonic performance. We have taken the outstanding success of our industry leading GL2200 and provided yet more innovative capability and enhanced performance for modern mixing.

- 16, 24, 32, 40 channel frames
- LR main mix
- Multi-mode M output
- 4 Group sends
- 6 Aux sends
- 7x4 Matrix
- Proper dual functionality for FOH/Monitor mixing
- Recording capable
- M can be configured as LR sum, C mix, Wedge, or Aux-Fed Sub master
- Sub grouping with pan control
- Matrix external inputs with level trims and common input capability
- 2 stereo channels each with mic and dual stereo line inputs
- Stereo channel mic input can cross patch into matrix for ambience feed
- Stereo channel line inputs can be assigned independently to LR
- Responsive 4 band, 2 sweep EQ
- 100Hz channel high pass filters
- Individual phantom power
- Polarity switching
- Channel and master meters
- Channel direct outputs
- Per channel pre/post fader aux switching
- Internal jumper plugs for pre/post-EQ aux, direct out and other options
- Mutes on all fader masters
- 100mm dust protected faders
- Assignable talkback
- 1kHz oscillator / pink noise generator
- 2-Track monitoring and replay to LR
- Headphones and local monitor outputs
- Dedicated stereo monitor meters
- Electronically balanced XLR outputs with +26dBu drive capability
- Preamp +34dBu maximum input capability for mic or line
- Ultra low noise mix head amp design
- Internal power supply with redundant backup supply input
- Metal jacks, gold-plated XLRs, sealed pots and switches
- Individual circuit card assembly with nutted pots
- Solid copper bus grounding
- Sys-Link V2 console linking option
- 4-pin lamp sockets

Here are just a few key points we considered when specifying the **GL2400**:

Affordability We understand your need to work within a realistic budget and know you want to get the very best return for your investment. We know too that even the lowest budget shows put the same tough demands on the operator who wants the reassurance of continued reliability and intuitive control, the satisfaction of achieving that special sound, and the functionality to deal with the trickiest situations. We have avoided the temptation of designing in costly plastic trims and needless external add-ons for styling only. Instead we have invested every penny of our budget into parts that make a real difference in improving performance, durability and flexibility of use, whether the comfortable soft feel armrest, the practically shaped space saving steel chassis, the wide viewing angle meter design, the exceptional feature set, or the 'under the bonnet' engineering such as the solid copper grounding strip, individual cards, circuit enhancements and more. The result is a no-nonsense, durable mixing tool right for its application... a sensible investment.

Reliability Without doubt, the most important quality for any equipment intended for the professional application. The **GL2400** uses the well proven and long term serviceable Allen & Heath method of individual channel card construction with every potentiometer nitted to the front panel, a solid steel chassis with rigid beam front extrusion, 100mm smooth travel faders with protective dust covers, metal bodied jacks and gold-plated Neutrik XLRs, and sealed Alps pots and switches to ensure you can mix with confidence show after show. The console power supply has a wide input range, plenty of overhead and even includes a backup supply capability for added security.

Performance The **GL2400** benefits from our latest circuit developments which have improved the sound and responsiveness of the mic preamp and EQ, and achieved astonishingly low residual noise from the mix head amp and output stages, crucial when mixing into modern high powered speaker systems. The new mic preamp maintains ultra low distortion and can accept as much as +34dBu to deal with the hottest signal you are ever likely to plug in. The XLR outputs provide proper differential drive up to a massive +26dBu to work with the longest and most hostile cable environments. Extensive listening evaluation together with solid engineering practice have ensured the console achieves accurate sound reproduction under all conditions.

Capability We know a thing or two about 'Dual Functionality' having pioneered this innovative feature back in the early 90's. The **GL2400** takes this an important stage further. Tamperproof recessed switches configure the console safely for optimum FOH or stage monitor operation, or for mixing monitors from FOH. In FOH mode you even get a fader controlled XLR 'M' output which can be configured to drive a mono PA or fill, or to work with an aux to create a 'C' mix within an LCR system, or as a convenient master control when using the increasingly popular 'aux-fed subs' technique. In MONITOR mode the 'M' fader becomes the engineer's monitor wedge control, you get all six aux masters available on faders with mutes, inserts, meters and electronically balanced XLR drive, and you still get the 4 subgroups to LR, and the groups/LR feeding the matrix. Unique at this price point we have added a 7x4 matrix to give you even greater mixing capability. For example, in FOH mode you can create independent fill speaker and acoustics compensated recording feeds, even capturing the atmosphere by cross patching the stereo channel mic preamps into the matrix to add individual or common mono or stereo ambience signals. In MONITOR mode the matrix gives you yet more monitor outputs easily created from the groups and LR with added ambience for the in-ear application. This compact console can feed up to 10 independent mixes, for example 6 wedges and 4 mono or 2 stereo IEM. We have also considered the RECORDING application with direct outputs on all mono channels, 4 groups, matrix and not least the studio quality analogue mic preamps and EQ. Whatever your application you get full control with nothing wasted.

Attention to detail In true Allen & Heath form, every detail has been meticulously thought through. Take for example, the compact, no frills chassis that gives you a seat saving, flight case convenient footprint, the provision of individual channel rather than restrictive global pre/post aux switching, comprehensive talkback, the built-in tone/pink noise generator for system checking, full channel and main output metering, the multi-functional stereo strips with patchable mic pre's and dual assignable stereo inputs, the host of internal pluggable jumper options, Sys-Link V2 console expansion... and much more. We hope you enjoy being as creative using the **GL2400** as our team enjoyed creating it.

Carey Davies, Head of Design, and sound guy too...

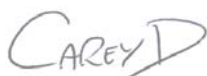

Installing the Console

The **GL2400** has a space saving, compact chassis design. This is convenient both in saving seats for the paying audience in a busy venue, and in reducing the size, complexity and weight of flight casing for on-the-road use. The control surface has a 10 degree slope for optimum visibility during operation. The rear connector panel has a split angle design for ease of plugging and unplugging the connectors.

Free Standing The console has rubber feet fitted for free standing operation on a flat surface. Make sure the surface is well supported, stable and big enough for the console to sit securely on all its feet. Allow enough space behind the console for access to its connectors.

Flight Casing The console is shaped for easy flight casing. Make sure it is supported on all sides using suitably thick, shock absorbent foam intended for this purpose. Ensure no part of the case or its lid touches the controls or connectors. If you include a rear 'doghouse' to house the connections make sure the cables can be supported in a way that prevents putting stress on the console connectors. To prevent transit damage through inadequate protection, we recommend you have the flight case supplied or approved by a professional, specialist equipment case manufacturer.



Do not obstruct the ventilation openings on the top and rear surfaces. Ensure adequate air flow around these surfaces. To avoid audible hum, buzz or other performance degradation, do not place equipment that radiates strong electromagnetic fields such as mains power supplies, amplifiers and computers next to or directly underneath the console.

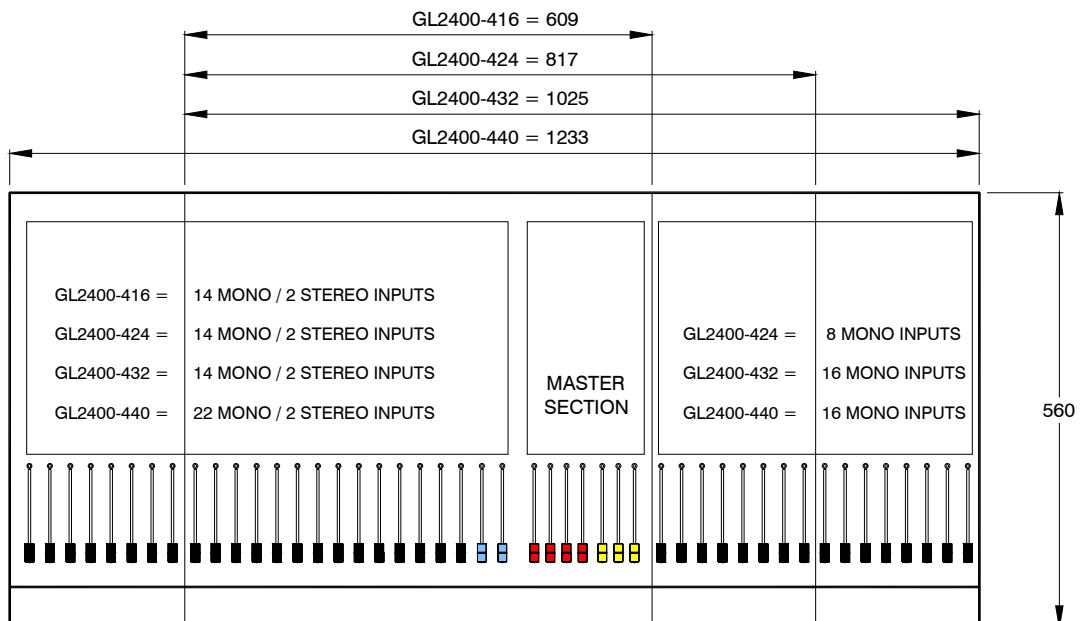
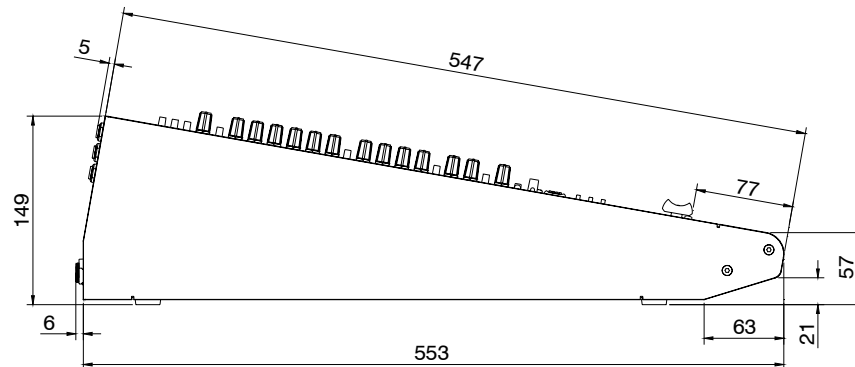

Connecting Power

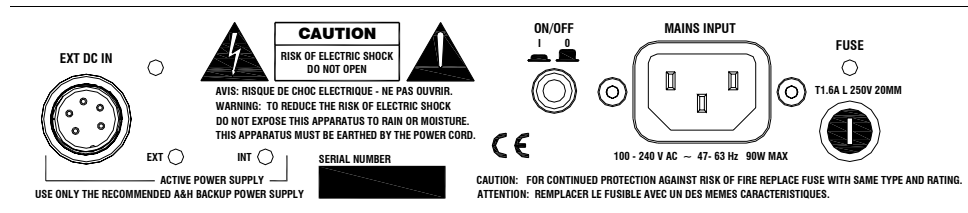

Read and understand the **Important Safety Instructions** printed at the start of this guide, and the warnings printed on the rear of the console. Check that the console power supply mains voltage input is the same as your local supply. Check that the correct mains lead with moulded plug has been provided with your console. Make sure that the IEC mains plug is pressed fully into the panel socket before switching on.

Grounding

The connection to ground in an audio system is important for two reasons:



1. **SAFETY** - To protect the operator from high voltage electric shock, and
2. **AUDIO PERFORMANCE** - To minimise the effect of ground (earth) loops which result in audible hum and buzz, and to shield the audio signals from interference.

For safety it is important that all equipment grounds are connected to mains ground so that exposed metal parts are prevented from carrying high voltage which can injure or even kill the operator. Do not disconnect the ground connection in the mains lead. It is recommended that the system engineer check the continuity of the safety ground from all points in the system including microphone bodies, turntable chassis, equipment cases, rack metalwork and so on.

Switching the console on and off

It is good practice to turn power amplifiers off before switching the console and any other connected equipment on or off. This prevents any unexpected clicks or thumps when the equipment is powered up.



Turn amplifiers and powered speakers on last and off first.

To turn the console on, press the ON/OFF switch next to the IEC mains input socket. To turn the console off, press this switch again.

Connecting a backup supply

A socket is included for plugging in an optional backup power supply. This provides the reassurance of power supply dual redundancy, a feature usually found only on expensive top end consoles. The console uses diode combining technology so that both supplies can be powered at the same time. One will automatically take over should the other stop working. The recommended backup supply for the **GL2400** 16, 24 and 32 models is the Allen & Heath **MPS12** power unit. The recommended backup supply for the 40 channel model is the Allen & Heath **RPS11** power unit.



Only plug the recommended Allen & Heath power unit into this socket. Do not attempt to modify any other power unit to work with the console. Do not attempt to modify or extend the DC power cable that comes with the supply.

The console can work with just the internal supply powered by mains, or just the backup supply, or with both powered at the same time. To ensure uninterrupted performance in the unlikely event of a failure, we recommended that both supplies are powered.

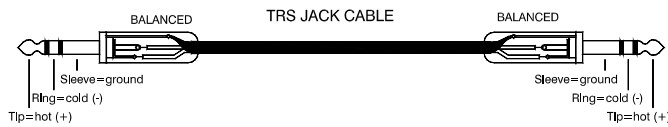
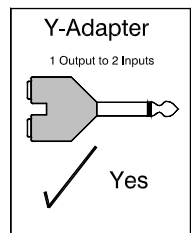
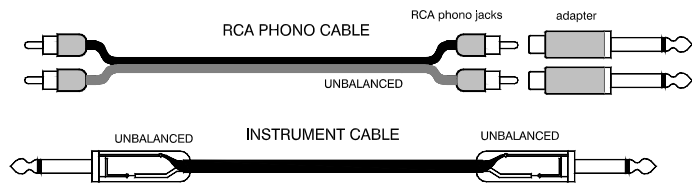
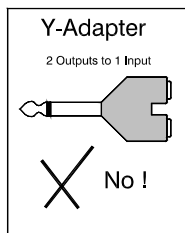
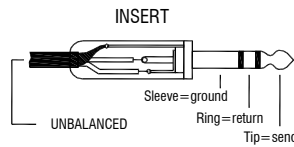
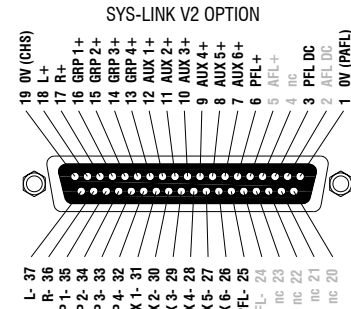
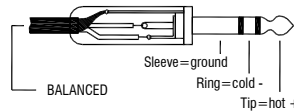
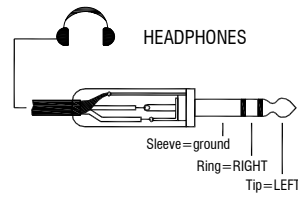
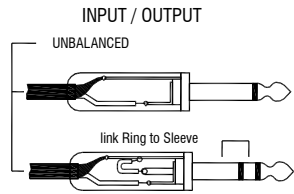
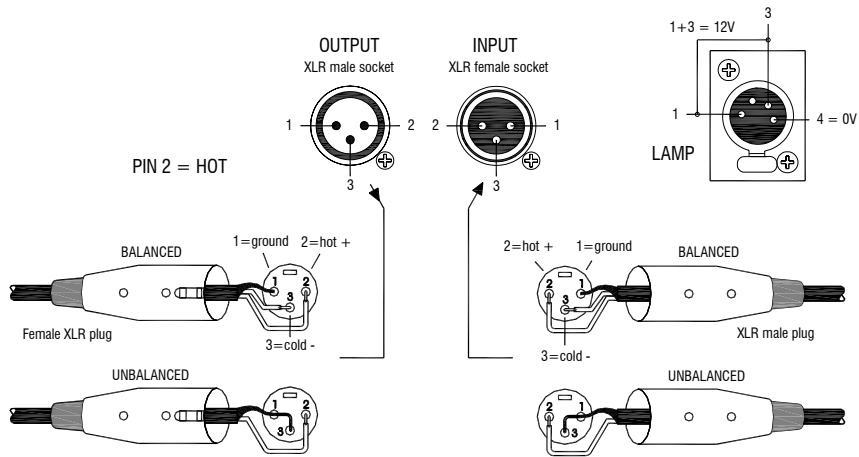

TO INPUT

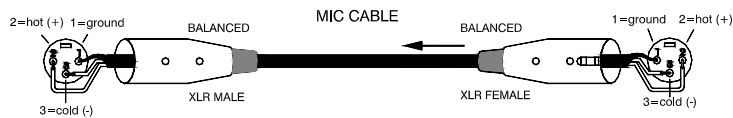

FROM OUTPUT

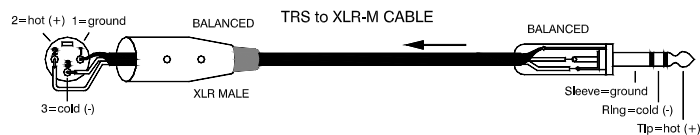
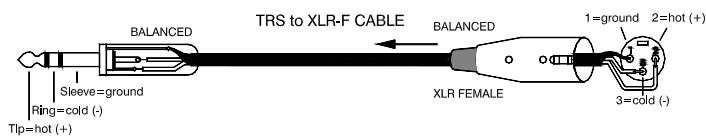

Audio Connections

The **GL2400** uses professional grade 3 pin XLR and 1/4" TRS (3 pole) jack sockets. To ensure best performance, we recommend that you use high quality audio cables and connectors, and take time to check for reliable and accurate cable assembly. It is well known that most audio system problems are due to faulty or sub standard interconnecting leads. The following plugs may be used to connect audio to the console:

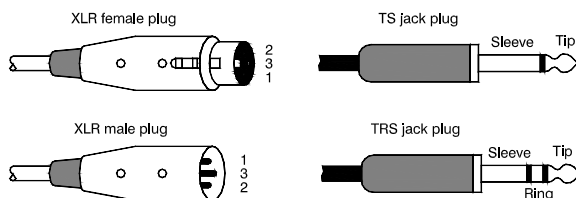

Avoid reversing + and - on balanced connections as this will result in reversed polarity (out of phase) signals which may cause signal cancellation effects.

Where long cables runs are required, balanced interconnections should be used. However, line level interconnections between more affordable 2-wire (signal, ground) unbalanced equipment and the console are unlikely to cause problems if the cables are kept shorter than 10 metres or so. Refer to the wiring diagrams on the opposite page.

Dealing with Ground Loops, Buzz and Interference

For optimum performance all audio signals should be referenced to a solid, noise-free ground (earth) point, frequently referred to as the 'star point' or 'clean earth'.

A ground loop is created when potential differences exist between grounds at different points in the system, and the signal has more than one path to ground. In most cases ground loops do not result in audible problems. Should you experience hum or buzz caused by a ground loop, check first that each piece of equipment has its own separate path to ground. If so, operate ground lift switches on connected equipment in accordance with the instruction manuals. Alternatively disconnect the cable screen at the destination end only. This breaks the offending loop while keeping the signal shielding down the length of cable.



WARNING For operator safety, do not remove the ground (earth) connection in the power lead of the console or connected equipment.

To avoid interference pickup keep audio cables away from mains power units and cables, lighting cables, thyristor dimmer units, computer equipment and mobile phones. Where this cannot be avoided, cross the cables at right angles to minimise interference

A note about balanced connections

A differentially balanced connection has two signal wires, signal + (hot) and signal - (cold) and a shield. The signal source generates positive going polarity down the + wire and negative polarity down the - wire. The destination input stage accepts the + signal on its non-inverting (+) input pin, but it inverts the - signal, adding it to the + signal. The result is that the wanted signal is boosted. Now examine what happens when unwanted interference (hum and noise) is induced into the cable. The noise is induced equally and with the same polarity into both wires. At the destination input the - wire signal gets inverted and added to the + signal. Because the polarity is the same on both input wires the noise cancels itself out at this input. For this interference rejection to work it is important that the source, the cable and the destination input are all balanced. Balancing provides greatest advantage with low level signals such as those produced by microphones.

An impedance balanced output provides similar interference rejection, but not as much maximum drive capability as the differentially balanced output, typically +20dBu versus +26dBu. It does not generate a negative polarity signal at its - output. Instead, the - wire has no signal but is held at the same impedance as the + wire. This means that both wires pick up the noise equally resulting in the advantage of noise cancellation as described above when connected to a balanced input stage.

The Console Connectors

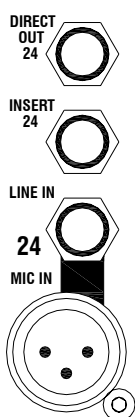

MONO CHANNEL MIC / LINE IN The LINE (PAD) switch selects either the MIC XLR or the LINE TRS jack as the input source. The XLR is normalled through the TRS jack so that it can be used for microphone or line level signals when nothing is plugged into the jack socket. This gives the channel preamp a massive headroom with +34dBu maximum input capability using XLR or jack. Both inputs are balanced but can be wired to work with unbalanced signals when required. The MIC XLR can be switched to provide +48V DC via 6k8 ohm resistors to pins 2 and 3 for microphones such as condensers which require phantom powering.

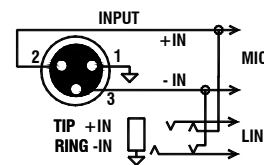

WARNING: Do not connect unbalanced sources or cables to the XLR input when 48V phantom power is selected. To avoid loud clicks always turn the channel off by pressing MUTE when switching +48V on or off, and when plugging or unplugging cables.

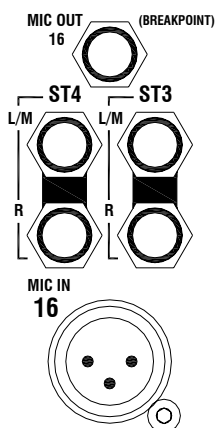

STEREO CHANNEL MIC IN Each stereo channel features a mono microphone XLR input and two independent stereo line inputs. The balanced MIC input accepts a maximum +14dBu and can be switched to provide 48V phantom power.

STEREO CHANNEL MIC OUT The output of the mic preamp is available on the MIC OUT (BREAKPOINT) TRS jack socket. This is impedance balanced and operates at a nominal 0dBu line level. **Plugging into this socket breaks the signal into the associated stereo channel.** This means that the mic preamp can be used independently of the channel, for example to create an ambience mic feed for recording, or as a preamp for an RTA measurement system.

STEREO CHANNEL LINE IN Stereo inputs **ST1** and **ST2** feed channel 15, and **ST3** and **ST4** feed channel 16 respectively, or can be routed directly to LR. These inputs use TRS jacks. ST1,3 are unbalanced, ST2,4 are balanced. Unbalanced inputs automatically connect the TRS ring to ground when working with balanced sources. The L input is normalled through the R socket to accept mono signals on a single jack.

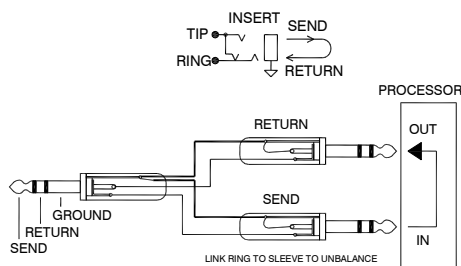

INSERT A single 3-pole TRS jack carries the unbalanced insert signal for each mono channel and main mix output. Tip = send, Ring = return, Sleeve = common ground. The channel inserts are post-HPF, pre-EQ and operate at 0dBu. The group (aux) and LR mix inserts are pre-fader and operate at -2dBu. Use these to patch in line level signal processing equipment such as compressors, outboard EQ, delay units and so on. The wiring of a suitable cable is shown in the diagram.

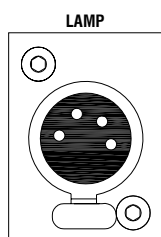

DIRECT OUTPUT Each mono channel direct output is available on an impedance balanced TRS jack providing a line level signal operating at 0dBu. The source is set using an internal option jumper for each channel. The factory default setting is pre-fade (following the pre/post-EQ setting). This may be changed to post-fade if preferred.

LAMP The 16 channel console has one, the larger models have two 4pin XLR sockets to plug in standard 12V gooseneck lamps to illuminate the operating surface when working in a dark environment. Only use lamps intended for this purpose. We recommend the Allen & Heath LEDlamp with cool white LED illumination and a built in dimmer.

Operating Modes

In **FOH mode**, LR feeds the main PA. M sums the L and R post-fade signals to provide an additional feed for a mono fill speaker or zone, or a main feed into a mono PA. Groups 1-4 may be used for multitrack recording, zone feeds and so on, or simply left unconnected where they are used as 'subgroups' to LR for level masters and/or inserted processing.

In **monitor mode** Groups 1-4 and LR XLRs and inserts become the aux mix masters. M becomes the engineer's listen wedge AFL/PFL feed. This configures the console with 6 main stage monitor and an engineer's output. The groups and LR are still available via the matrix to provide yet more monitor feeds.

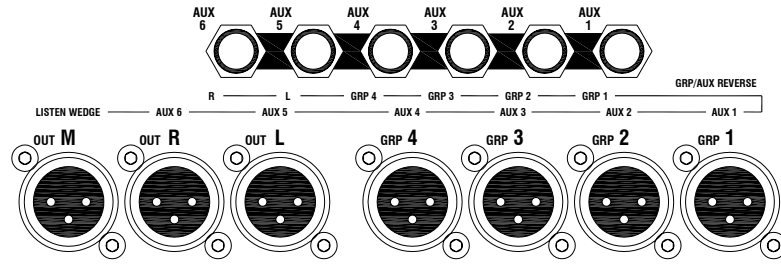

GROUP, L, R, M OUT The main console mix outputs are on electronically balanced XLR. These produce the professional standard +4dBu when the meters read '0', and provide up to a maximum +25dBu. The L and R outputs typically feed the house PA system in live sound mixing, or a 2-track recorder in studio mixing. In **monitor mode**, these outputs reverse with the Aux TRS jack connections.

AUX OUT 1-6 Each aux send is available on an impedance balanced TRS jack operating at -2dBu line level. An internal option is available to fit a balanced line driver IC to provide an electronically balanced output operating at +4dBu. Note that it is not usual to require this option as the impedance balanced standard drive provides sufficient interference rejection when feeding balanced equipment inputs. The aux sends are typically used to feed monitors, effects devices such as reverb and delay, and for special mix requirements. In **monitor mode**, these outputs reverse with the group and LR XLR connections.

MATRIX OUT 1-4 Each matrix output is available on an impedance balanced TRS jack operating at -2dBu line level. An internal option is available to fit a balanced line driver IC to provide an electronically balanced output operating at +4dBu. The matrix outputs are typically used for stereo or mono recording or broadcast feeds, delay and fill speakers, zone feeds, additional monitors such as IEM, hearing assist loops and so on.

MATRIX EXT IN 1-4 Each matrix has an unbalanced 0dBu line level TRS jack input. An external signal such as ambience mix, additional or sub mixer, remote source, reference tone and so on may be mixed in to each matrix. The inputs are normalised as shown in the diagram here. This means that you can plug in just one jack (EXT1) as a common source to all matrix, two jacks (EXT1,2) as a common stereo source to matrix pairs, or four independent sources. This is ideal for adding mono or stereo ambience to recordings or in-ear monitors fed from the matrix.

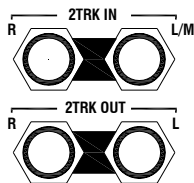
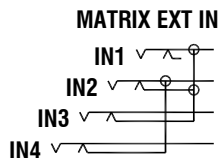
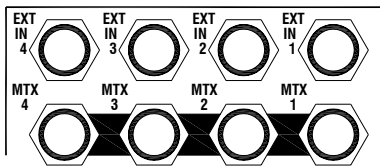

2-TRACK IN and OUT Unbalanced TRS jack outputs and TRS inputs connect to popular recording and playback devices such as CD, MiniDisc, computers and tape machines. Nominal line level is -2dBu. The 2-track SEND always follows the post-fade LR mix regardless of mode switch configuration. The 2-track RETURN can be used for monitoring a mono or stereo recording, or as a simple input for playback of walk-in and background music. The L input normals through the R socket for plugging in a mono source on a single jack.

MONITOR OUT These impedance balanced line level TRS jack outputs follow the post-level monitor signal. Separate sockets are provided for the L and R signals. Use these to feed local speaker or other monitor systems.

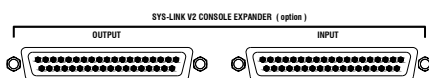

SYS-LINK V2 OPTION A blank plate is fitted here as standard. The GL2400 Sys-Link V2 (version 2) input/output option kit is available from Allen & Heath. Refer to OPTIONS later in this guide.

The MONO Input Channel

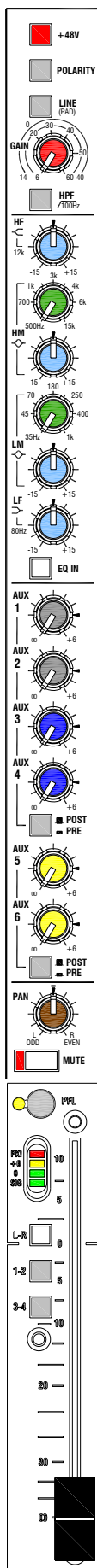

+48V Switches +48VDC to the channel input XLR for powering microphones or DI boxes that need phantom power. The power is current limited through 6k8 ohm resistors to pins 2 and 3.

WARNING: Do not connect unbalanced sources or cables to inputs with phantom power selected. To avoid loud clicks always mute the channel before switching +48V on or off and when plugging or unplugging microphones.

POLARITY Reverses the polarity (+ and – connections) of the input source. Useful when using the ‘above/below’ mic technique, for example when miking a snare drum with two microphones, or for correcting mic placement and cable wiring errors.

LINE (PAD) Press this switch to select the channel TRS jack LINE input. Release the switch to select the XLR MIC input. The XLR normals through the TRS socket. With nothing plugged into the line input the switch therefore becomes a PAD for the mic XLR. It attenuates the input signal by 20dB for connection to high level microphone or line sources. This gives the mic preamp a massive 74dB range and headroom of +34dB to deal with the hottest signals.

GAIN Adjusts the input sensitivity to match the connected source to the internal 0dBu operating level of the channel. Provides a variable 54dB range from +6 to +60dB gain (mic), or -14 to +40dB (line, padded mic). The gain should be set so that the channel meters average ‘0’ with loudest moments lighting ‘+6’. Reduce gain if the red peak indicator lights.

Important note on setting channel levels: Use PFL to set the GAIN controls for correct signal level through each channel. The main LR meters provide a high resolution display of the channel signal level. Use the faders to balance each signal in the mix. To ensure optimum gain structure we do not recommend the practice of setting the faders to ‘0’ and mixing using the GAIN controls.

HPF Switches in the channel high pass filter. This attenuates frequencies below 100Hz by 12dB per octave. The filter is pre-insert, pre-EQ. Select the HPF to reduce low frequency noise such as microphone popping, stage noise and tape transport rumble.

EQ A responsive 4-band semi parametric EQ (equaliser) provides independent control of four frequency bands. Use EQ IN to compare the sound with the equaliser switched in or out of circuit.

HF and LF are shelving filters which affect high frequencies above 12kHz, and low frequencies below 80Hz respectively. HM and LM are bell shaped peak/dip filters which affect frequencies around a centre point which can be swept from 500Hz to 15kHz, and 35Hz to 1kHz respectively. These have a width (Q) of 1.8 which provides effective control for both creative and corrective equalisation. The EQ curves shown opposite display the signal level response at maximum boost and cut as the frequency varies from low (20Hz) to high (20kHz).

All bands can be boosted or cut by up to 15dB and have a centre detent 0dB position. The overlapping frequency ranges let you deal with challenging source problems easily using combinations of bands.

Check that you are using the best microphone type and placement before using the EQ. Start with the EQ set flat and apply only as much boost or cut as is really needed. When dealing with problem frequencies cut rather than boost where possible.

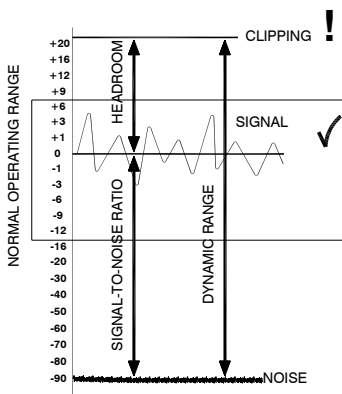
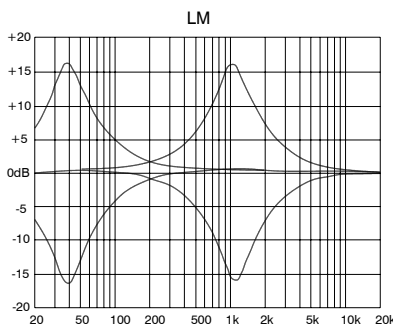
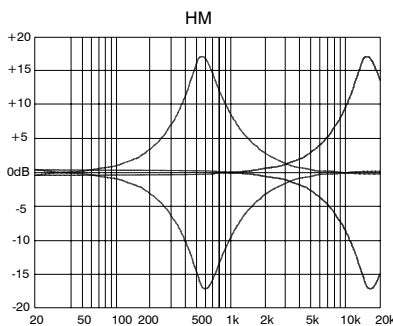
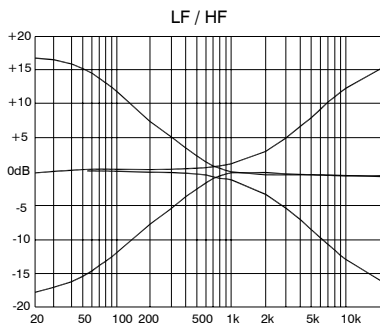
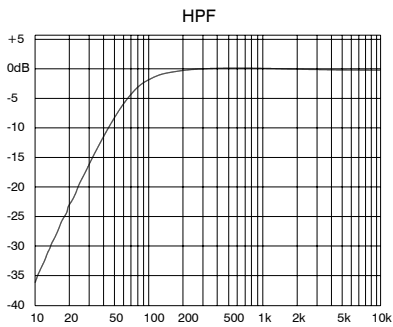

AUX SENDS These rotary controls adjust how much channel signal is mixed to the aux outputs. Each of the 6 auxes has its own control. They adjust from fully off to +6dB boost. Unity gain 0dB is marked at 3 o'clock position. Auxes 1-4, 5-6 are switched pre/post. The settings may be changed if preferred by repositioning internal jumper link options. They offer several different combinations of pre and post-fade sends, and a post-EQ option for the pre-fade sends. More detail is provided in OPTIONS later in this guide.

Pre-fade aux sends are not affected by the channel fader movements. These are typically used to feed stage monitors. In most cases users also prefer that the monitor sends are not affected by inserted processors or the channel EQ. Post-fade aux sends follow the channel faders and are typically used to send a proportion of the channel signal to an effects device such as reverb or delay. Note that post-fade sends may be preferred when the console is configured in monitor mode so that the faders become 'masters' for all monitor mixes. Pre or post-fade sends may also be used for special applications such as recording, zone feeds, clean feeds and aux fed subs or centre speaker.

PRE When pressed, the pre-fade channel signal is sent to the associated auxes. When released, the post-fade signal is sent. Auxes 1 to 4 and 5, 6 are grouped for pre/post switching. Default setting is pre-insert, pre-EQ so that inserted compressors and EQ do not affect the sends when mixing monitors from FOH. You can change this by repositioning the internal option jumpers.

PAN Positions the channel signal between L/R in the stereo mix, and odd/even if routed to the groups. The centre position (mono image) is detented for quick resetting.

MUTE When pressed, the channel signal is turned off. This affects the feed to the LR mix, pre and post-fade aux sends and direct output, but does not affect the insert send. The red indicator lights when the channel is muted. Always mute the channel when switching phantom power or plugging the cables and sources.

PFL Press PFL to listen to the pre-fade channel signal in the headphones and local monitor without affecting the main outputs. The console PFL/AFL active red indicator lights and the monitor LR meters display the channel signal. The PFL switch yellow indicator lights to show that PFL has been selected on that channel. Selecting more than one PFL at the same time mixes those signals together in the monitor.

METER A 4 LED channel meter displays the pre-fader signal level. 'SIG' lights when a signal level of -12dBu is detected. '0' lights when the nominal 0dBu level is reached, and '+6' at +6dBu. 'PK' lights when the channel pre-fade signal is within 5dB of clipping. This gives you enough warning to reduce GAIN before you hear signal distortion.

ROUTING Press L-R to route the channel signal to the main LR mix. Press 1-2 or 3-4 to route to the groups. Use PAN to position the signal between L/R or the odd/even group pairs. To route to a single group set PAN fully to one side. You can route to L-R and all groups simultaneously by pressing all switches. Check that you have set these switches correctly before you start mixing.

FADER A high quality 100mm smooth travel fader with protective dust cover controls the channel level feeding the main LR mix, groups and post-fade aux sends. It also affects the direct output if this has been set to post-fade using the internal option jumpers. The fader provides +10dB maximum boost above its normal unity gain 0dB position.

The STEREO Input Channel

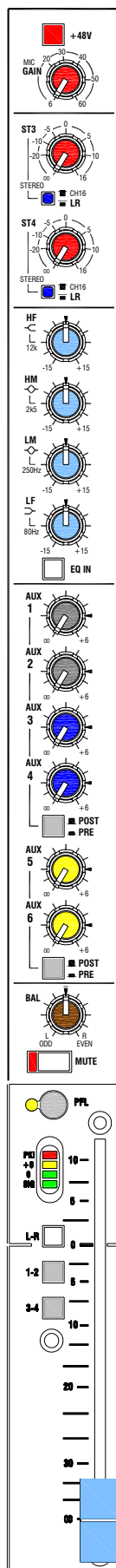

Each **GL2400** stereo channel features a mono microphone preamp as well as two stereo line inputs. These three sources can be used independently or mixed together into the channel, so providing a unique flexibility. For example, you could configure a conventional mono microphone channel with the two 'short return' stereos routed direct to LR for effects. Alternatively you could patch the mic stage as an independent preamp for an ambience microphone feeding a recording, or for a system calibration microphone, while the ST line inputs mix two external stereo effects processor returns or sound effects players via a single channel. This can be useful in saving channels, letting you mix many inputs in a small space. Of course, one stereo could feed the channel, the other route direct to LR. Two stereo channels could be linked so that the mic preamps cross patch to provide one stereo mic and one stereo line channel, with two 'short returns' also available... See 'Operating Tips' later in this guide.

MIC INPUT Similar to the mono channel microphone preamplifier without the line (pad) and polarity switches. Gain and 48V phantom power switching are included. A rear panel MIC OUT breakpoint socket is provided so that the mic stage can be used independently. Plugging a jack into the MIC OUT socket breaks its signal path to the stereo channel.

DUAL STEREO LINE INPUTS Each stereo channel has two stereo inputs which can be used separately, mixed together or split so that one feeds the channel, the other routes direct to LR. ST1 and 2 feed channel 15 (23), ST3 and 4 feed channel 16 (24). The L input signal is normalised through the R input socket so that a mono source may be plugged in to feed both left and right sides of the stereo channel. Each input has its own level control to adjust from fully off to +16dB gain. Centre position is unity (0dB) gain.

Routing mode switch Recessed to prevent accidental operation. In the normal up position the ST signal mixes into the associated stereo channel. When pressed the signal is routed direct to the LR mix instead of the channel.

EQ Similar to the mono channel, but the two peak/dip mid bands are fixed at 250Hz and 2.5kHz centre frequencies.

AUX SENDS These work as described for the mono channel, but the L and R sides of the stereo signal sum together to feed each aux in mono. This can be changed using an internal jumper so that L feeds the odd numbered auxes and R feeds even. The auxes can be switched pre or post-fader but are always sourced post-EQ.

BAL Balances the level of the L signal against the R signal to compensate for differences in the source, or to position the signal within the stereo image.

MUTE When pressed, all the channel pre and post-fade signals are turned off except the MIC OUT and any stereo routed direct to LR.

PFL Press PFL to display the summed L+R pre-fade channel signal on the monitor meters and listen to it in the headphones and local monitor without affecting the main outputs.

METER As the mono channel, but the left and right signals are summed to display in mono.

ROUTING As the mono channel, but routes the left signal to L and odd groups, right signal to R and even groups.

FADER The stereo fader provides +10dB maximum boost above its normal unity gain 0dB position

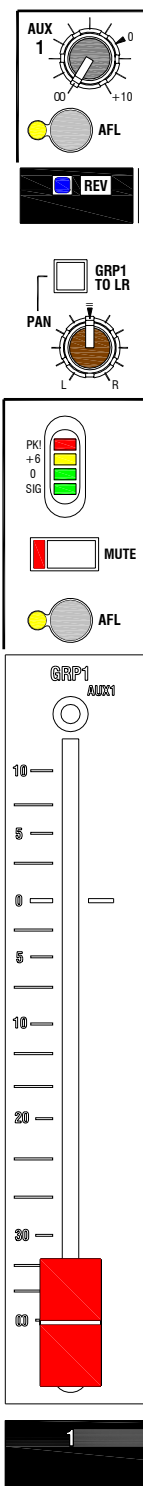

AUX MASTERS Each aux mix has a master level control that adjusts the output level to match external equipment, or trims the monitor, effect or other send without affecting the mix balance. Up to +10dB boost is available above the normal 0dB position. Note that this becomes the group or master in monitor mode.

AUX AFL Press AFL to listen to the post-level aux mix in the headphones and local monitor without affecting the main outputs. The console monitor meters are interrupted with the aux (group) signal. The yellow indicator lights to show that AFL has been selected on the master. Use AFL to check the signal being sent to the monitors, effects or other destination. AFL is pre-mute so that you can check the signal before sending it to its destination.

REV mode switch These switches reverse the function of the group and aux masters, the heart of the dual functionality pioneered by Allen & Heath. They are recessed to prevent accidental operation. Use a pen or pointed object to set their position. In the up position (flush with the panel), the group is controlled by the fader and the aux by the rotary master. This is typical for FOH mode where the faders are used for subgroups feeding the main stereo mix. When pressed, the aux uses the fader as the master and the group is moved to the rotary control. The aux mix is now presented to rear Group XLR complete with insert. The group mix appears at the Aux TRS jack. This is used for monitor mode where the auxes are the main mix feeding the stage monitors. You can select any combination for the FOH and monitor mode, for example, just 3, 4 giving you two fader subgroups, two monitor sends on faders, and main LR mix.

Note: The groups always feed the matrix and the subgroup controls (PAN and GRP TO LR) regardless of mode. This means the group mix can still perform a useful function when the console is configured in monitor mode.

PAN Positions the group signal between L and R in the stereo mix when the GRP TO LR switch is pressed. Using pan you can create mono or stereo groups positioned as you require in the main mix. For stereo grouping, set the odd group pan fully to the left, and the even group pan fully to the right. The centre position (mono image) is detented for quick resetting. Note that the group mix always feeds these subgroup controls regardless of FOH or monitor mode selected.

METER A 4 LED bar meter displays the post-fade group signal (FOH mode), or aux signal (monitor mode, REV pressed).

MUTE When pressed the group (aux) signal is turned off. This affects the feed to the output XLR, LR and matrix. The red indicator lights when the channel is muted.

GROUP AFL Press AFL to listen to the post-fade, pre-mute group mix in the headphones and local monitor without affecting the main outputs. Note that this becomes the aux mix in monitor mode. The console monitor meters are interrupted with the group (aux) signal. The yellow indicator lights to show that AFL has been selected on that master.

GROUP FADER A 100mm smooth travel fader controls the group mix output level. Note that it becomes the aux mix master in monitor mode (REV pressed). The fader provides +10dB maximum boost above its normal unity gain 0dB position.

The AUX 5-6, L-R-M Masters

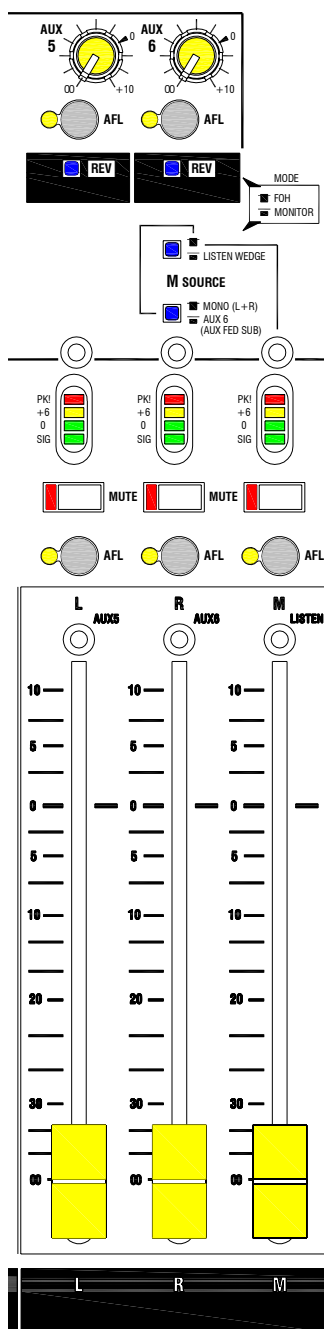

AUX 5 and 6 Masters These function in the same way as described for auxes 1 to 4. In monitor mode, the recessed REV switch reverses the AUX5 master with L, and AUX6 with R. Here the aux signals are presented to the L and R XLR outputs complete with their inserts. The LR mix swaps on to the Aux TRS jack outputs. Note that the LR mix always feeds the matrix and 2-track regardless of mode selected.

LR Masters Separate 100mm faders control the main mix L and R output levels. They provide +10dB maximum boost. Each master includes a 4 LED bar meter, an AFL switch and a MUTE switch so that L and R can be separately monitored and muted. This is most useful in monitor mode where these masters carry the AUX5 and AUX6 signals.

M Master A 100mm fader adjusts the level of the signal to the M output XLR. The master is fully featured and includes a 4 LED bar meter, an AFL switch and a MUTE switch.

The M output adds a true touch of genius to the versatility of the **GL2400**. The source is selected using two mode switches above the R fader. These are recessed to prevent accidental operation. Use a pen or pointed object to set the position.

FOH mode – With both switches in the up position (flush with the panel), the post-fade L and R mix are summed together to provide a mono source. Use this to feed a mono PA, fill, delay or zone speakers, or even a mono broadcast or recording send.

Monitor mode - Press the upper switch to create an engineer's monitor listen wedge feed from the AFL/PFL mix. Note that in this mode the M AFL switch is disabled. It is common to use a wedge speaker of the same type used on stage to listen to and check the various monitor mixes being sent to the performers. Together with the group/aux REV function, the **GL2400** can be configured as a compact yet fully featured monitor console.

Aux-Fed-Subs mode – Press only the lower switch to configure M as the master for AUX6. This innovative feature is ideal when driving your sub bass speakers with their own mix fed from an aux, a technique becoming more popular in FOH mixing. This mode provides all the main PA masters (L, R and SUB) with faders, meters, MUTE and AFL. Using the faders you can adjust the level of the main PA without losing the balance between the tops and subs. The signal is not affected by the AUX6 rotary master. However, the rotary output can still provide another sub feed with its own independent master control.

Route all sources to LR in the usual way to feed the main 'top' speakers. In addition, route sources with low frequency content such as kick drum, bass, keyboards, sound effects to the sub speakers by turning up the AUX6 send rotary on those channels. Make sure all channel aux 5-6 sends have been set for post-fader operation. Use two crossovers, one for the stereo LR mid/top frequencies, the other for the sub feed. Set the system up so that the correct balance between tops and subs is achieved when the channel send is at its '0' (3 o'clock) position and the L, R and M faders in line with each other.

Aux-Fed-Centre mode – The same principle as above, but AUX6 is used to feed a centre mix such as a fill or C in an LCR system. To route to C only, turn up the channel AUX6 send to 3 o'clock unity position, and turn off its assignment switch to LR.

The matrix adds to the powerful multi-tasking capability of the **GL2400**. It provides a set of 4 additional console outputs. It is a 'mixer within a mixer' creating its output from any combination of the groups, main LR mix and external input. It can be used to provide duplicate main outputs or to create new mixes from these outputs. The matrix controls are positioned conveniently away from the live performance controls to avoid accidental operation.

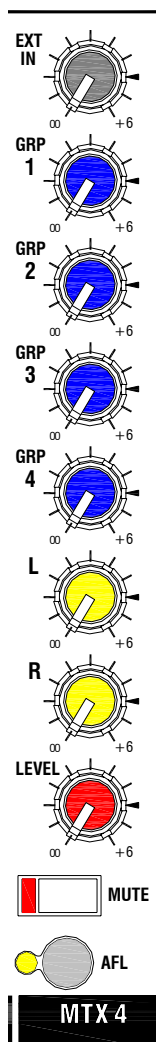

Use the matrix to create special mixes for delay fill and zone speakers, recording and broadcast feeds, IEM (in-ear monitors), hearing assist loops and so on. Mono and stereo feeds can be created. For example, mix L and R to create a mono sum output to feed an additional zone, or use two matrix outputs with L fed to one, R to the other to create an independent stereo main output. Mix in an external source such as an ambience microphone preamp to add atmosphere and audience reaction to a recording or monitor. Compensate for an acoustically loud backline by boosting selected groups in a live recording. For more information, refer to 'Operating Tips' later in this guide.

EXT IN Mixes in an external nominal 0dBu line level source. The rotary provides +6dB boost. Note that EXT IN jack sockets are normalised (linked) in a way that lets you plug in a mono or stereo common source to feed all the matrices, or an independent source to each. Plug into EXT1 only to feed one source to all four matrix EXT IN controls. Plug L into EXT1 and R into EXT2 only to feed a stereo source to matrix 1-2 and 3-4.

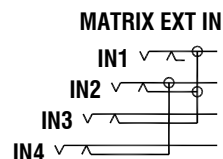

Some examples include adding ambience sources to recordings and in-ear monitoring, adding a direct output or an aux mix to quickly create a monitor from the main mix plus selected channel/s, and linking in another console to feed the same PA in a festival or other dual console situation.

GRP 1 (2,3,4) Mixes in the post-fader, post-mute group mix. The rotary provides +6dB boost.

L (R) Mixes in the post-fader, post-mute main LR mix. The rotary provides +6dB boost. Turn up both L and R to create a mono sum from the stereo LR mix. Turn up L in one matrix, R in another to create a stereo output from two matrices.

LEVEL The master level control (fader) for the matrix. Provides +6dB boost above the normal '0' setting.

MUTE When pressed the matrix output is turned off. The red indicator lights when the matrix is muted. Mute does not affect the matrix AFL monitoring.

AFL Press AFL to listen to the post-level matrix mix in the headphones and local monitor without affecting the main outputs. The console monitor meters are interrupted with the matrix signal. The yellow indicator lights to show that AFL has been selected on that master. Note that MUTE does not affect the AFL function. This means that you can check the matrix signal while its output is muted.

MONITOR, TALKBACK and SIGNAL GENERATOR

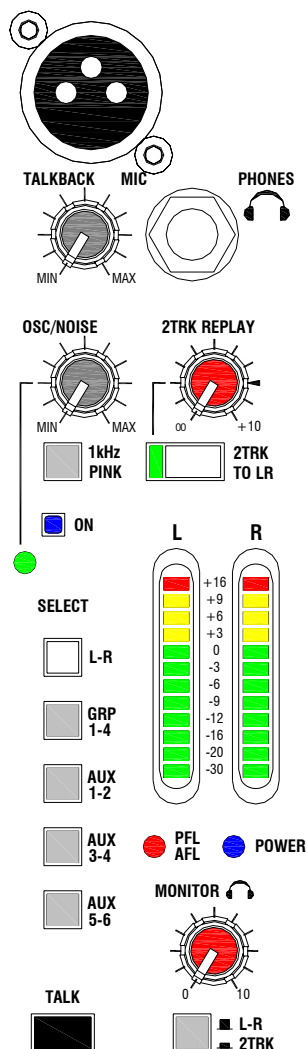

Console Monitor Comprehensive engineer's headphones and local monitoring is provided. Select either LR or 2-track return as the default source using the L-R / 2TRK switch. Pressing PFL or AFL elsewhere on the console automatically overrides the current monitor source with the signal from the channel or master selection. The red PFL/AFL active indicator illuminates and the console meters display the active signal.

The console monitor meters provide 12 LED indicators to accurately display the signal level of the selected monitor source. Reduce the gain or level if the red '+16' peak indicator lights. For optimum performance the signals should be adjusted to read an average '0' with loudest peaks reaching around '+6'.

Use the MONITOR level control to adjust the level in the headphones and local speaker monitor. We recommend you use closed ear headphones in the range 30 to 600 ohms designed for live sound monitoring. 100 ohm headphones are a popular choice.

WARNING: To avoid damage to your hearing do not operate any close-to-ear monitoring such as headphones for long periods at high volume. Continued exposure to high volume sound can cause frequency selective or wide range hearing loss.

TALKBACK Individually assignable talkback is available to all the main outputs. Plug in a suitable cable or gooseneck microphone. A good quality dynamic or condenser vocal microphone is recommended. Note that +48V phantom power is available at the XLR as standard. If you prefer, this can be disabled by repositioning an internal jumper link.

WARNING: Do not connect unbalanced sources or cables to inputs with phantom power selected. To avoid loud clicks do not press the TALK switch when plugging or unplugging the talkback microphone.

First select the source you wish to talk to. You can select the auxes in pairs, useful for communicating with the performers on stage. The four groups are selected simultaneously, ideal for identifying a multitrack recording. You can also talk to LR, ideal for announcements to the audience. Once selected, press and hold TALK to route the mic to the required destination. Adjust the talkback level using the TRIM control below the TB mic XLR. Pressing TALK automatically dims the level of the signal generator if it is turned on.

SIGNAL GENERATOR / PINK NOISE Press to select either pink noise (up position) or a 1kHz sine wave tone as the test source. Start with the trim control turned fully down. The generator ON switch is recessed to prevent accidental operation. Press this with a pen or pointed object. The green indicator lights to warn that the generator is enabled.

The generator signal is routed to any source selected on the switch bank above the TALK switch. Use the signal to test the loudspeaker system and line up connected equipment. Pink noise is useful for quickly testing the full range frequency operation and phasing/polarity of loudspeakers. The 1kHz tone is better suited to lining up equipment with its steady reading on the meters.

WARNING: We recommend you turn off the signal generator once you have finished using it to test and line up your system. This will prevent accidental operation during the show.

GL2400 Applications and Operating Tips



The following is a collection of brief descriptions, application notes, hints and tips to help the operator understand some of the technical terms referred to, and to get the most out of the uniquely capable **GL2400** live sound mixing console. They are written as a concise reference to spark your imagination to creatively and effectively deal with the many challenges now faced in modern day mixing.

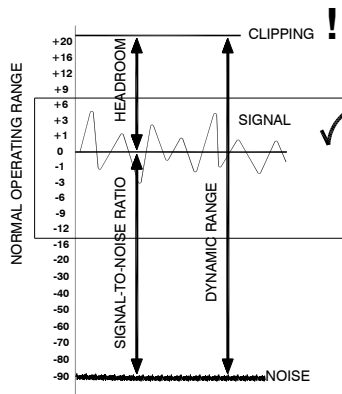

Gain Structure The term used to describe the gain (level) matching of the signal through the audio system chain. Each item in the equipment chain has its own optimum ('nominal') operating level determined by its electrical circuits. If you overload it with a signal that is too high then its output tries to produce more voltage than its power rails can provide resulting in harsh sounding distortion as the audio signal is 'clipped'. If you work with a signal that is too low then you are likely to hear the residual hiss of the circuits as the 'noise floor' is amplified along with the signal. The optimum operating level is the point at which the signal is high enough above the noise floor so that the hiss is not heard (good 'signal-to-noise' ratio, the SNR), yet provides enough space ('headroom') before clipping to allow for the louder, dynamic musical moments without distortion. 'Dynamic range' specifies the maximum range between noise floor and clipping. It is the sum of the SNR and headroom. The larger the figure the better... less noise, more headroom, more forgiving to wide ranging signals.

A microphone produces a very tiny signal, for example -50dBu (a few millivolts). This should be amplified by the channel preamp to the optimum operating level of the console circuits, around 0dBu (0.775V), well clear of the noise floor (typically less than -90dBu), and with good headroom (typically clipping at greater than +20dBu). With a channel routed at unity gain from preamp input to main output, the **GL2400** boasts a massive 116dB dynamic range. The signal can pass through many stages which affect its level within the console; the channel, its EQ, fader, pan, a group mix and its fader, on to the main LR mix with its master fader, through the matrix, and of course any inserted equipment. The output XLR provides the professional standard +4dBu (1.23V) nominal level to the next stage in the audio chain, typically a speaker processor such as limiter or crossover, or straight to the amplifier. The amp boosts this signal to tens of volts to move the speaker cones so producing the audible sound.

☺ A search on the Internet can reveal a host of additional information on setting correct gain structure and many other audio topics and educational resources.

To get the best performance from your system, it is important that you set up the gain structure correctly within the console and also within and between the connected equipment. Ideally, each circuit should be set to clip at the same time if the signal became too hot, in other words each would have similar headroom relative to its nominal operating level. The resulting dynamic range is the difference between the highest noise floor and the lowest headroom through the system. The performance is only as good as the weakest link.

The **GL2400** provides comprehensive metering to check every point within the console signal path. Use the channel meters and PFL/AFL system to set the gains and mix levels to average around '0' meter reading with usual peaks around '+6'. Reduce the gain if the red '+16' or 'PK' indicator lights.

Use the equipment meters to set each item within the system path to operate at its nominal level. We advise that the speaker processor or amplifier trims are set so that the console outputs can drive up to their nominal '0' level. It is a common mistake to set amplifier trims to maximum sensitivity when this results in the console master faders being operated at very low positions, with low meter readings, and reduced dynamic range and therefore audible residual system hiss.

Using the Oscillator / Noise Generator The **GL2400** includes a useful signal generator able to produce a pure 1kHz sine wave tone, or a pink noise test source. This is invaluable in testing the system components and setting up correct gain structure. The generator can be routed independently to the various console outputs.

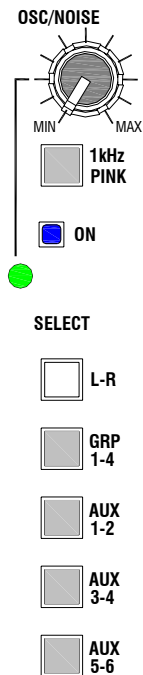

Use the **1kHz tone** to line up the connected equipment. For example, a recorder, video camera or broadcast feed from the matrix. Route the tone to the groups and turn up GRP1 in the matrix. Set the matrix GRP1 and LEVEL controls to their 3 o'clock '0' positions. Press the matrix AFL and adjust the oscillator level until the console monitor meters read '0'. Next, adjust the recorder input trim so that its meters also read '0'. The recorder is now correctly aligned to the operating level of the console. Similarly, you could match the console LR output to a DSP speaker processor by sending the tone to LR, setting the faders for output meters reading '0', and then trimming the processor input for '0' on its meters. To prevent a loud tone through the speakers it is best to do this with the amplifiers turned off.

Use the **Pink Noise generator** to check the signal routing and loudspeaker response. 'Pink noise' is a random signal that contains all audio frequencies and is therefore a very good test source. Unlike 'white noise' which has equal energy per Hz and sounds like system or inter-band tuner hiss, pink noise has equal energy per octave, a response that matches the logarithmic way our ears perceive sound. You can hear all the frequencies clearly from deep bass, through mid to treble. This means you can route the noise to a speaker system and quickly hear if one of the sub, mid or HF drivers is faulty. With the noise sent to several speakers at the same time you can listen for comb filtering effects, and the severe phasing effect which indicates that one of the speakers may have its wires reversed. Pink noise is also used with an RTA (real time analyser) when measuring room frequency response. Testing a system with pink noise through the speakers is often referred to as 'pinking the room'.

The **GL2400** signal generator is an invaluable tool for calibrating and testing the system during setup. To prevent any unexpected mishaps during the sound check or show, remember to disable it by releasing the recessed ON switch once you have finished the testing. We also advise that you always start the calibration with the OSC/NOISE trim turned fully off so that you can bring it up gradually without the risk of overloading the destination.

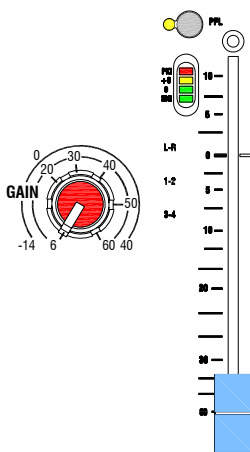

Mixing with faders or gain controls? There is a technique used by some operators where they set all the faders to '0' position and balance the mix using the channel gain controls. We do not advise this method as the signal to noise ratio and control resolution can be severely degraded. In addition, it is impossible to mix monitors from FOH in this way as changes to the gain settings affect the monitors too.

The correct method is to use **GAIN** to match the source to the operating level of the channel for optimum dynamic range, and then use the **FADERS** to balance each source into the mix. With correct system gain structure, prime sources such as vocals would have their faders operated around '0' while sources low in the mix such as backing vocals and acoustically loud brass and drums would display their true contribution with their lower fader positions. This is a much more visual and accurate way of mixing.

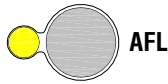

Using PFL / AFL Allen & Heath are renowned for bringing you the most comprehensive engineer's monitoring system in consoles at this price point. We recognise the importance of correct gain structure and signal handling. The **GL2400** includes LED meters for every input channel and main output, as well as a pair of high resolution meters dedicated to monitor duty only. In monitor mode the M fader and associated controls become a full featured PFL/AFL monitor feed for the engineer's listen wedge.

The input channels provide **PFL** (pre-fade listen) so that each source can be checked using the meters and headphones before you bring the fader up. You can even use PFL while the channel is muted to prevent the signal reaching the house and monitor speakers until you have checked it and are ready.

All the main, aux and matrix outputs provide **AFL** (after-fade listen) so that you can check the exact level leaving the console. Once again, the AFL switch gets its source before the output mute switch so that you can check the signal before you send it to its destination. This can be very important when you are feeding remote destinations such as broadcast and recording.

dB Tech talk...

For an audio circuit stage:
 P_i = Input signal power
 P_o = Output signal power

The Decibel is defined as:

$$\text{dB} = 10 \log (P_o / P_i)$$

$$= 10 \log (V_o^2/R_o / V_i^2/R_i)$$

If input and output impedances R_i and R_o are the same, then:
 $\text{dB} = 20 \log (V_o / V_i)$

dBm is defined as 1mW into 600 ohms = 0.775V

dBu = 0.775V ignoring the 600 ohms as we assume high input and low output impedance and therefore maximum voltage transfer between stages, appropriate for modern audio.

The Decibel the 'Bell' is the unit of sound level. Decibel is 1/10 Bell, a more conveniently sized unit. $\text{dB} = 20 \log (V_o / V_i)$ where V_i and V_o are two signal voltages, in and out (ignoring the impedances). The dB is used to express the relationship between two levels, chosen because of the logarithmic way our ears respond to sound. The 'dB' relates one level to another. For example, a preamp with a gain of 40dB (100x) would produce an output of +10dBu for an input of -30dBu. Several audio standards exist to relate a signal level to a known reference. Audio engineers need to deal with a variety of equipment standards, for example, a -10dBV CD player plugged into a console with +4dBu outputs connected to a 0dBu input DSP speaker manager, or an operator using an SPL (sound pressure level) meter to measure sound intensity.

- dBu** Relative to 0.775Vrms – professional standard
 $0\text{dBu} = 0.775\text{V}$ $+4\text{dBu} = 1.228\text{V}$
- dBV** Relative to 1Vrms - consumer audio standard
 $0\text{dBV} = 1\text{V}$ $-10\text{dBV} = 316\text{mV} = -8\text{dBu}$
- dB-A** Sound pressure with a filter contour to approximate the response of the human ear. Three curves A, B, C exist for different loudness.
- dBfs** Relative to signal maximum before clip (full scale)

☺ If you suspect the insert socket to be faulty or intermittent through excessive wear or contamination, test for this by plugging in a jack with its tip shorted to its ring contact. This bypasses the contact in the socket. Clean using suitable electrical contact cleaner.

Using Inserts The **GL2400** channel inserts operate at 0dBu, the output inserts operate at -2dBu. In practice this makes little difference as long as the inserted equipment is intended for line level operation (-6 to +4dBu). Simply set the gain through the device to unity (0dB) with the bypass switch pressed (if available). With the effect switched in, use the console channel gain control to make any further adjustments needed. This keeps the gain structure correct through the channel signal path.

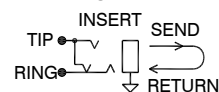

With nothing plugged into the insert, the channel signal is routed through a switching ('normalling') contact in the socket. As soon as a jack is plugged into the socket the contact is opened and the signal path broken so that the external device can be patched in series with the signal.



POLARITY

Polarity Refers to the positive (+) and negative (-) wires of a loudspeaker or balanced audio connection. The console input channels include POLARITY switches which reverse the + and - input connections. Some applications include correcting for reverse wired cables, correcting for microphone placement problems, mixing two mics on a snare drum, one above the other below where the diaphragms move in opposite directions, and helping to reduce comb filtering effects as radio miked actors perform close to each other. Polarity is sometimes labelled 'phase' on mixing consoles. Technically, 'phase' is not the correct term as it implies a 180 degree time shift. Polarity simply reverses the wires. It does not affect time. Before starting your mixing, check that all the channel polarity switches are correctly set, normally up (+).



Mixing the PA in mono or stereo? Because a console provides an L and R output does not mean you have to mix in stereo. It is often convenient to have separate fader control, processor inserts, and outputs to drive two mono speaker stacks in an FOH system. How much stereo you introduce into your mix depends on where you position the pan controls. In most situations the size of the room and position of the speakers makes stereo mixing an advantage only for a small section of the audience, usually those around the sound operator! Those listening near the speakers are likely to lose information from the opposite stack. For this reason it is best to mix most sources in mono (pan centred). However, it can enhance the image by mixing some 'ambient' sounds in stereo, for example reverb returns, keyboards and special effects. Where the speakers are widely placed, you can reduce the stereo image by reducing the amount of panning to each side. Whatever image you create it is important that you listen to the results and consider the listeners at all positions in the room.

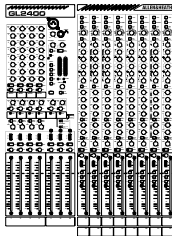

Zero the console Before starting the sound check it is good practice to 'zero' the console by setting all its controls to a sensible starting condition. Set all GAIN, EQ and PAN controls mid, FADER, AUX and MATRIX controls off, TALKBACK and OSC/NOISE levels off, and all switches up. Make sure the osc/noise generator is turned off. Cue Sheets are provided at the rear of this user guide for you to copy and log your control settings. These can also be downloaded from our web site.

Think before you hit the switch!



Turning the system on and off It is good practice to:

- Turn the amplifiers on last and off first.
- Mute channels before plugging cables, unplugging instruments and switching phantom power.
- Let equipment which has been stored in a damp or cold place acclimatise in the venue first before powering it up.
- Power up the system in plenty of time before you start the sound check or show.



Sound levels The ear is a delicate instrument. Do not subject yourself or any listener to long periods of loud sound, particularly with extreme equalisation. This may result in frequency selective or full range hearing loss. Adhere to the sound level regulations which may apply to the venue... and common sense!



Dual Functionality Now an industry standard, Allen & Heath pioneered this feature with the introduction of the first GL consoles in the '90s. In the past it was necessary to stock two different types of live sound console, one for mixing FOH (front-of-house), the other designed for mixing on-stage monitors. With the introduction of a few clever 'mode' switches we changed all that. Now, the same console can be quickly configured to carry out either task properly and without compromise.

The **GL2400** takes dual functionality a thoughtful stage further with the advent of new engineering practices such as multi-media and IEM (in-ear monitor) mixing, and computer based live multi-track recording. The key principles of dual functionality are:

- FOH / Monitor**
 - The same console can be quickly configured by the operator for proper FOH or stage monitor mixing, or as a combination of both for mixing monitors from FOH. In either mode, no part of the console is redundant. Every control and socket can be used for an associated function.
- Protected**
 - To prevent accidental operation during the show, the configuration mode switches are safely recessed under the panel.
- Aux Reverse**
 - In FOH mode the groups and LR are the main outputs while in Monitor mode the aux mixes become the main outputs.
- Master Control**
 - The REV switch swaps the group or L, R master controls with the related aux master so that you have full fader control of the appropriate main output complete with mute, AFL and LED bar meter.
- XLR + Inserts**
 - In Monitor mode the aux outputs are routed to the console main XLR sockets for electronically balanced drive, with inserts for patching in processors such as graphic EQ, limiters and delays.
- Pre/Post**
 - Channel pre/post switches and link options are important. In Monitor mode it must be possible to switch all auxes post for channel fader mastering. For Monitors from FOH, the pre-insert, pre-EQ or post-EQ option is needed.
- Sub Grouping**
 - In Monitor mode the groups continue to feed the sub grouping to LR so that you can still work with grouped level control to the main mix.
- Matrix Feed**
 - In Monitor mode the groups and LR continue to feed the matrix so that you can create independent mixes in addition to the auxes for special feeds, recording, and further mono or stereo in-ear monitors.
- Listen Wedge**
 - In Monitor mode the M output becomes the engineer's 'listen wedge' feed providing the PFL/AFL mix. It gives the engineer identical fader control and XLR drive for all wedges including their own.
- Talkback**
 - In both modes assignable talkback is provided.
- Ambience**
 - The matrix has a useful application in both modes. External ambience sources can be mixed in to the matrix to create live recording and in-ear monitor mixes.

FOH	Monitor	Recording
LR + M	10 Monitors	Stereo / Mono
Aux-fed Subs	6 Aux (wedge)	2-Track
Aux-fed C	4 Matrix (IEM)	4 Groups
4 Groups	Engineer's Wedge	4 Matrix
6 Auxes	Ambience	Direct Outputs
4 Matrix	Talkback	Ambience

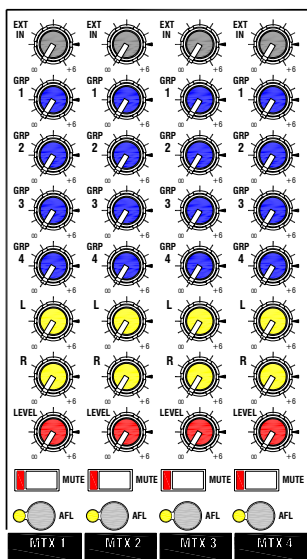

Applications for the Matrix The matrix is a 'mixer within a mixer', a versatile toolbox of outputs you can use to satisfy a host of applications. Each of the 4 outputs is mixed from any combination of the groups, L, R and an external input as dialled up on the 7 source rotaries (hence a '7x4' matrix). Its master level can be adjusted independently. Using combinations of the outputs you can create mono, stereo or multiple output mixes. Some applications include:

Mono Recording If you are working with a stereo PA you can combine L and R into a matrix output to produce a mono mix feeding a recorder, video camera and so on. Raise the L and R rotaries to the 2 o'clock position to sum them together. You can use the built-in 1kHz tone generator to feed a line-up tone to the connected recorder.

Stereo Recording Raise L to the unity 3 o'clock position in one matrix, R in another to create a stereo pair that follows the LR mix. You can adjust the balance to compensate for the acoustic sound in the room using the groups, and even add audience ambience (described later).

Remote Broadcast Create a mono or stereo feed as described above. Use the tone generator to send a 'slate' signal to the destination for line-up. You can check your level in the headphones before you send it by muting the matrix and selecting AFL.

Zone Feeds Send independent relay feeds to additional locations such as the foyer, dressing rooms, cry room, balcony and so on. You can use the groups to adjust the balance to suit the destination, for example to boost the orchestra against the vocals. Feed the output through an EQ to tune the speaker for the local acoustics.

Delay Fill Speakers Use the matrix to feed additional fill speakers for distributing the sound more evenly around a large venue, for example centre fill, stage front fills, under balcony or rear fills, or 'mix island' delay tower at a festival. To aid intelligibility for the nearby listeners without moving their focus from the stage, the send should be delayed using an in-line delay processor. As a rule of thumb, delay 1mS per foot difference between the listener and the fill and the listener and the main speakers. Now add a few milliseconds 'Haas effect' delay so the listener hears the main speakers slightly before the fill. Keep the fill level about 10dB or so below the main PA sound at that location. It may help intelligibility to boost the vocals above the instruments in the fills, and to use an EQ to cut the extreme LF and HF frequencies.



Hearing Assist It is a growing requirement that venues provide a hard-of-hearing inductive loop, IR or wireless broadcast for the hearing impaired audience. The matrix is ideal for this application as you can combine a stereo LR mix into mono, add groups to help vocal intelligibility, patch in an external ambience source, and add processing such as EQ and limiters which may be needed.

Additional Monitor Mixes You could use the matrix to create some additional monitor mixes when you run out of auxes, this time made up from a mix of the groups, LR and external input. The LR could be used to create a general overall balance, and then the groups added according to musician preference. Groups could be routed from 'me only' channels associated with each musician, or traditionally grouped sources. The musician could get a balance from, say, the overall stereo mix, drums, brass, keyboards, 'me only' and ambience, a very quick way of mixing. You could also use the EXT IN to add ambience pickup, very useful if you are creating in-ear (IEM) mixes. Use two matrices to create stereo monitor feeds.

Combining Two Consoles into a Single PA In a festival situation you may have a support band wishing to patch in their own console. One way to do this is to feed the PA from a pair of matrices, and then use EXT Inputs to combine the external console with the main LR mix.

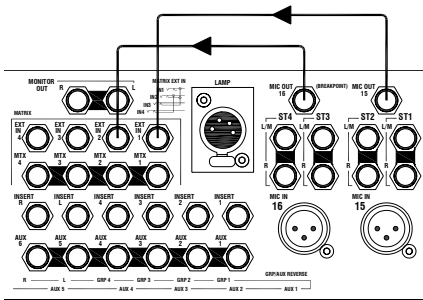

Create IEM Mixes with Ambience In Monitor mode the matrix continues to be fed with the 4 groups, L and R mixes. You can use these to create additional, independent monitor mixes. Together with the auxes these give you as many as 10 mixes. Create mono or stereo in-ear monitor feeds using single or paired matrices, for example MTX1-2 and 3-4. You could use LR to start with a basic stereo mix, then add up to four instrument or 'more me' groups. Add ambience using a pair of jack leads to patch the stereo channel MIC Outputs 15 and 16 into matrix EXT IN 1 and 2. With nothing plugged into EXT IN 3 and 4 the two mic signals are automatically linked across making the same stereo ambience available to both IEM mixes. Alternatively you could use an outboard reverb effects processor fed from a post-fade aux send to create the ambience. Use the channel faders and pan to create the basic stereo mix. Remember to set the other monitor aux sends to pre-fade.

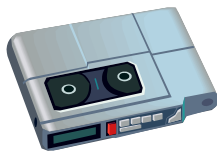

Using the Matrix to create a Recording The band may be acoustically loud in the room, and you need only mix vocals and some of the instruments into the PA to get good clarity and overall balance for the listeners. If you recorded the console main output you would be disappointed when you got home and listened to the result. For example, there may be strong voices, acoustic guitar and flute, but the drums, bass and electric guitar may be low. This is because you did not need much of these backline instruments in the PA mix. However, if you use the matrix to feed the recording you could start with the main LR (PA) mix, then turn up the drum and guitar groups to compensate for the lack of these in the house system. You could also add in ambience as described above to give the recording more life by including audience reaction and natural reverberation.

Recording with the GL2400 The console is equally at home recording live or in the project studio. The studio grade preamps produce an accurate and noise-free recording. Create a stereo recording from the main LR output, or from a pair of matrices as described above if recording and mixing live at the same time. To record to multitrack use whichever combination of groups, matrix, auxes and channel direct outputs is most convenient. The direct outputs are set pre-insert, pre-EQ as factory default. This setting means that the recording is not affected by your live fader and EQ changes. Note that you can swap internal jumpers to change this to post-EQ, and post-fade if you prefer. Post-EQ lets you use the EQ for source correction to affect both live sound and recording. Remember to use some ambience microphones to record the audience and venue atmosphere too.

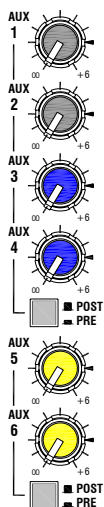

Pre/post Fade Aux Settings The aux sends are switched pre or post fader using two PRE switches on every channel. One switch affects auxes 1-4, the other auxes 5 and 6. It is usual to set auxes pre-fade if you are mixing monitors from FOH. Set post-fade for auxes used as effects sends, zone feeds, aux-fed subs and so on. If you are using the console to mix monitors only then the auxes are typically set post-fade so that the channel fader becomes the source master to all monitors. In this case start with all channel faders set to '0'.



There are times when you may want some monitor sends set post-fade while most are set pre-fade, for example mixing monitors with radio mics and cued sound effects. Here, it may be better for the radio mics to follow your fader movements so avoiding off-stage chat or noise in the monitors. **For this reason we believe it is important that channel rather than global mix pre/post switching is provided.**

Aux-Fed Subs Driving the PA system sub bass speakers with their own mix has two main advantages. First, the mix is much cleaner because only sources that generate the low frequencies, for example kick drum, bass guitar and keyboards, are sent to the subs. Low frequency bleed from these sources into open microphones such as vocals and snare is eliminated from the PA much more effectively than using just the channel filters. Second, the sub bass amplifier is only working with the sources needed. It is not wasting power reproducing unnecessary pickup.

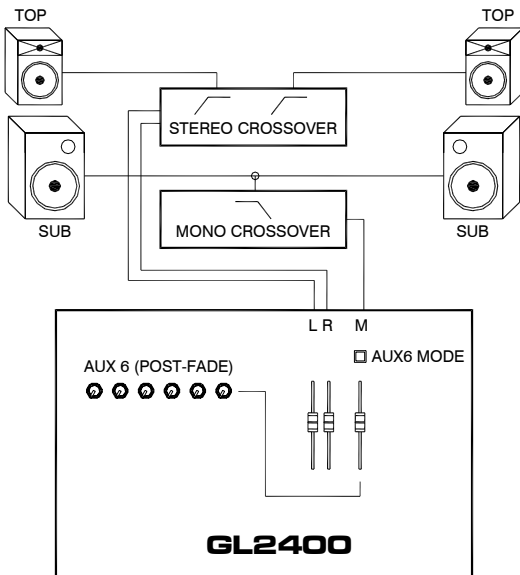

The sub can be separately driven in several ways, for example using a group, a mono or 'C' bus, or using an aux. Using an aux send has become a popular method on the smaller consoles. Simply feed the LR to a stereo crossover to drive the top speakers, and a post-fade aux send to a mono crossover to drive the sub speakers. Refer to the speaker manufacturer for recommended crossover frequency, usually within the range 80Hz to 120Hz. Align the system so that the normal unity gain position of the channel fader and aux send result in the correct speaker balance.

For sources you wish to send to the sub, turn up the channel aux send to its unity 3 o'clock position. Avoid the temptation to ride the aux send to create more or less sub as this may upset the natural speaker balance or cause problems for listeners in different parts of the room.

One problem with using the aux in this way is that it becomes difficult to balance the top and sub speakers if you need to adjust the overall volume of the PA. Typically the LR (tops) use fader masters, and the aux is on a rotary master. The **GL2400** overcomes this with an innovative mode switch above the master faders that routes the AUX6 mix master through the M fader and on to the XLR output. This switch is recessed for protection against accidental operation. The result is you get three master faders aligned for simultaneous control, individual mutes, AFL and meters, and three properly balanced XLR outputs. Note that the AUX6 rotary master does not affect this sub feed. It does however independently affect the AUX6 jack output. This gives you a further advantage that another sub can be separately controlled using the rotary master, for example to supplement the stage monitor mix.



Creating a separate C mix As with the aux-fed sub mix described above, you can set the mode switch to create an independent mix feeding a dedicated centre or mono speaker. The channel AUX6 sends become the routing to this mix while the M fader with XLR output becomes the master, correctly aligned with the L and R faders. Set the channel aux sends to unity 3 o'clock position, and release the LR routing switches if you do not want the signal in the LR speakers as well. The **GL2400** gives you the choice of either mixing the sum of L and R to the M output (mode switch up), or an independent AUX6 mix to M (mode switch pressed).

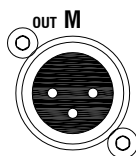
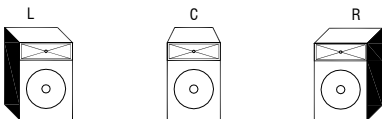

Other M Output Applications Apart from the aux-fed subs and C mix described above, other examples include L+R sum mono fill, additional mono zone feed, mono recording, mono PA with LR providing two subgroups to M or a stereo recording... and more.



Using the channel Direct Outputs Default factory setting is pre-insert, pre-EQ, pre-fade so that your live fader mixing, effects and EQ do not affect the recording. Change this to post-EQ using internal jumpers if you prefer to use the EQ for source correction affecting the recording too. You could also patch DIR OUT into a matrix EXT IN to add a 'more me' channel into a monitor send created from the groups and LR. If preferred you can reconfigure the direct outputs to post-fade by setting internal jumpers. Use post for feeding an effects processor with one source only, for example a dedicated reverb on lead vocals, or to add more of one source into a matrix fed recording.

Using the Stereo Channels Stereo channels 15 and 16 present a unique flexibility. Each provides a microphone input and two stereo inputs, a total of five connections which can feed the channel or be routed elsewhere. The mic preamp has a TRS jack MIC OUT breakpoint so that its output can be used independently. Plugging into this socket breaks the signal path feeding the channel and routes it to the jack instead. Each stereo input has its own level control and can be routed either into the channel or directly to the LR mix. This is configured using a recessed mode switch which protects it from accidental operation during a show. With 2 mic and 4 stereo line inputs, channels 15 and 16 provide for a host of space saving applications:

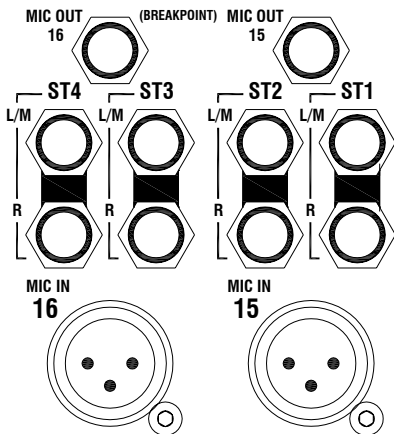

Standard Mono Microphone Channels Mono mic input through the channel with 4band EQ, auxes and full routing. Press the mode switches to re-route the stereo inputs direct to LR for simple effects returns and source inputs.

True Stereo Microphone Channel For example, use short jack leads to patch both channel 15 and 16 MIC OUT breakpoints into ST2 stereo line input. Set ST2 level control to its mid '0dB' position to feed the channel. Adjust the gain and balance between the left and right microphones using the two mic GAIN controls. Route ST1 to LR as a simple effects return or source input. The other channel can be used as a dual stereo input fed from ST3/4, or as a single ST4 input with ST3 routed independently to LR.

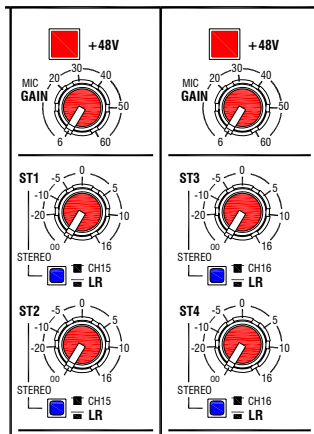

Mixing Two Microphones through One Channel As above but patch CH15 MIC OUT into ST1 L/M, and channel 16 MIC OUT into ST2 L/M. Set ST1 and 2 levels to mid '0dB' position. This mixes the two mics together in mono, for example when using one channel for two choir microphones. CH16 is available for stereo line sources.

Patchable Microphone Preamplifier Disconnect the mic preamp from the channel and patch it elsewhere to be used independently. For example, plug in a room microphone and patch MIC OUT to a matrix EXT IN to add ambience to a recording or monitor feed, or use it as a preamplifier for a reference microphone with an RTA or other analysis equipment. You could even use it to provide a better mic source to a video camera or other recorder.

Dual Stereo Line Inputs A trademark of Allen & Heath consoles is the ability to combine more than one source into the stereo channel, each with its own level control. This can save channel space when working with two similar sources routed to the same destination, for example, two stereo reverb returns, two backing track or sound effects players, or to alternate between walk-in music and recorded announcement players.

Finally... A Note about Combining Signals You can use a 'Y' splitter cable or adapter to feed one output to two destinations, but never try to combine two outputs to one destination. This may damage or degrade the performance of the equipment driver stage.



Specifications

Performance

Maximum input level	Mic	+34dBu (inc pad)
	CH Line	+34dBu
	Other Line	+20dBu
Maximum output level	XLR	+26dBu
	Jack	+20dBu
Internal headroom	Channels	+20dB
	Mix	+22dB
Meters	3 colour LED, quasi peak response	
Sensitivity	0VU = +4dBu at XLR output	
Master meters	12 segment	-30 to +16dB
Channel meters	4 segment	-12,0,+6+16dB (5dB before clip)
Frequency response	20Hz to 50kHz	+/-0.5dB
Mic CMRR at 1kHz	> 80dB typical	
THD+n at +14dBu 1kHz	Channel to mix out < 0.003%	
Crosstalk at 1kHz	Fader shutoff	>90dB
	Mute shutoff	>90dB
	Inter channel	>90dB
Noise, rms 22Hz to 22kHz	Mic EIN	-128dB
	Residual output noise	< -96dBu (-100dB S/N)
	LR mix noise 16 routed	< -86dBu (-90dB S/N)
	Group mix noise 16 routed	< -86dBu (-90dB S/N)
	Aux mix noise 16 routed	< -92dBu (-90dB S/N)
	Mix noise 16 line 0dB gain	< -86dB S/N
Channel HPF	12dB/octave below 100Hz	
Mono EQ	HF	Shelving +/-15dB, 12kHz
	HM	Peak/dip +/-15dB, 500Hz to 15kHz, Q=1.8
	LM	Peak/dip +/-15dB, 35Hz to 1kHz, Q=1.8
	LF	Shelving +/-15dB, 80Hz
Stereo EQ	HF	Shelving +/-15dB, 12kHz
	HM	Peak/dip +/-15dB, 2.5kHz, Q=1.8
	LM	Peak/dip +/-15dB, 250Hz, Q=1.8
	LF	Shelving +/-15dB, 80Hz
Power supply (16-32 ch)	Internal switched mode, auto sensing, IEC input External input for optional MPS12 backup supply	
Power supply (40 ch)	External RPS11 linear, IEC input Console Input for second RPS11 as backup supply	

Mechanical

	16	24	32	40
Width	609mm (24")	817mm (32.2")	1025mm (40.4")	1233mm (48.5")
Depth	560mm (22")			
Height	150mm (5.9")			
Weight	16.5kg(36.3lbs)	21.5kg(47.3lbs)	26.5kg(58.3lbs)	32kg(70.5lbs)

Connections

Mono channel	XLR balanced pin 2 hot	Sensitivity -60 to +14dBu
	TRS balanced, tip hot	Sensitivity -40 to +14dBu
	Pad out (MIC)	2k ohm
	Pad in (MIC or LINE)	>10k ohm, -20dB attenuation
	Max input level	+34dBu
	XLR phantom power	+48V, on/off
Stereo channel	ST1,3 TRS unbalanced	>10k ohm, -16 to +20dBu
	ST2,4 TRS balanced	>10k ohm, -16 to +20dBu
Talkback mic	XLR balanced pin 2 hot	Sensitivity -50 to -10dBu
	Phantom power	Internal jumper +48V
2-track return	TRS unbalanced	>4k ohm, -2dBu
2-track send	TRS impedance balanced	<75 ohm, -2dBu
Inserts	Channel	TRS, tip send, ring return, 0dBu
	Output	TRS, tip send, ring return, -2dBu
L, R, M outputs	XLR balanced pin 2 hot	<75 ohm, +4dBu, +26dBu max
Group (aux) out	XLR balanced pin 2 hot	<75 ohm, +4dBu, +26dBu max
Aux 1-6 output	TRS impedance balanced	<75 ohm, -2dBu, +20dBu max
	Electronic balance option	<75 ohm, +4dBu, +26dBu max
Direct out	TRS impedance balanced	<75 ohm, 0dBu, +20dBu max
Matrix out	TRS impedance balanced	<75 ohm, -2dBu, +20dBu max
	Electronic balance option	<75 ohm, +4dBu, +26dBu max
Headphones	TRS, tip L, ring R, 30 to 600 ohm headphones recommended	
Monitor output	TRS impedance balanced	<75 ohm, -2dBu, +20dBu max
Lamp	4-pin XLR	max 12V 5W lamp

GL2400 Series Part Numbers

14 mic/line, 2 mic/dual stereo, 4 group console	GL2400-16/v
22 mic/line, 2 mic/dual stereo, 4 group console	GL2400-24/v
30 line, 2 mic/dual stereo, 4 group console	GL2400-32/v
38 line, 2 mic/dual stereo, 4 group console	GL2400-40/v
Sys-Link V2 input/output option kit	GL2400-SLV2
SSM2142P balanced output driver option IC	AE0302
DRV134 balanced output driver option IC (alternative to above)	AE5725
Backup power supply option for the 16, 24 and 32 models	MPS12/v
Backup power supply option (for the 40 channel model)	RPS11/v
Allen & Heath 18" gooseneck LED lamp – right angled	LEDLAMP-X

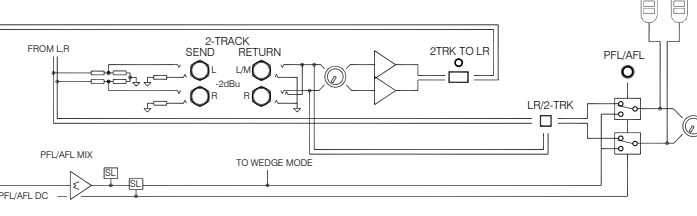
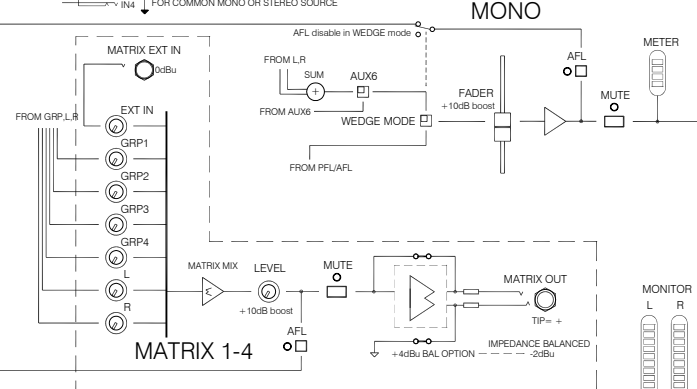
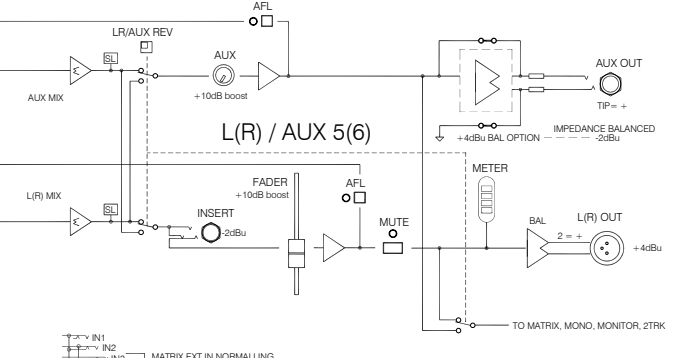
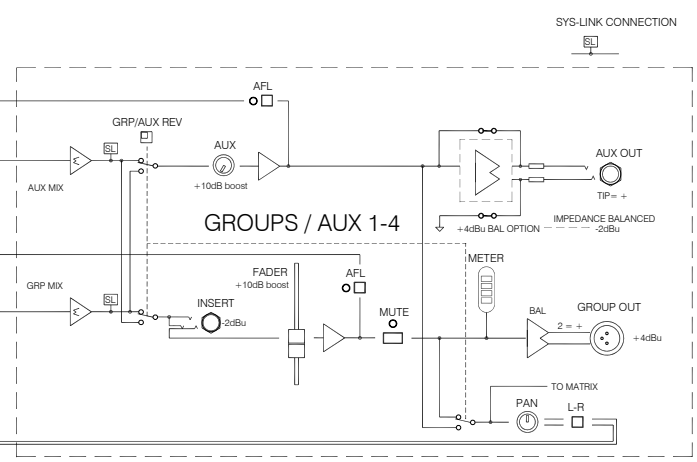
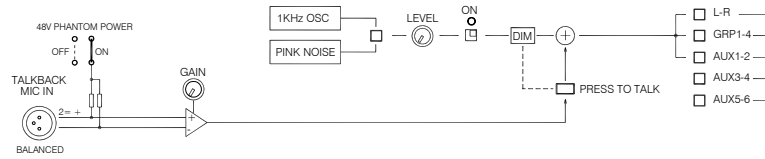
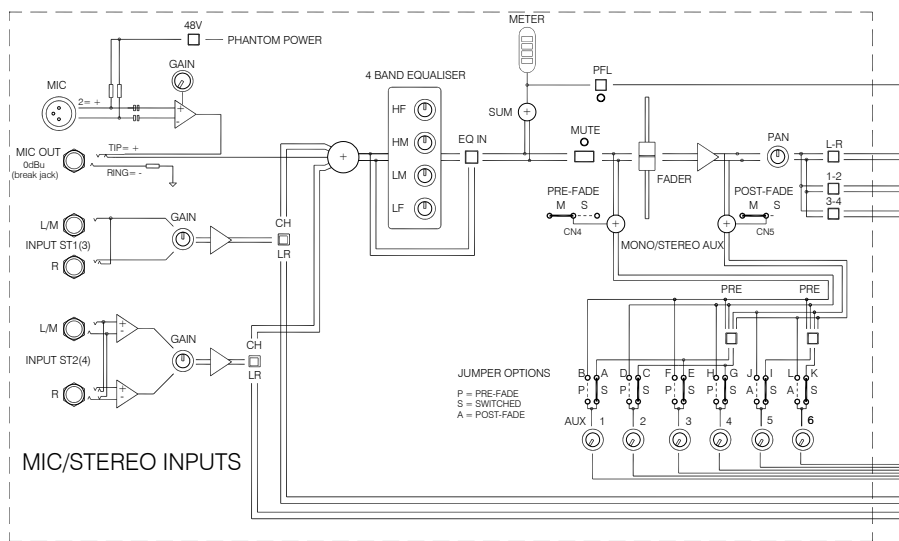
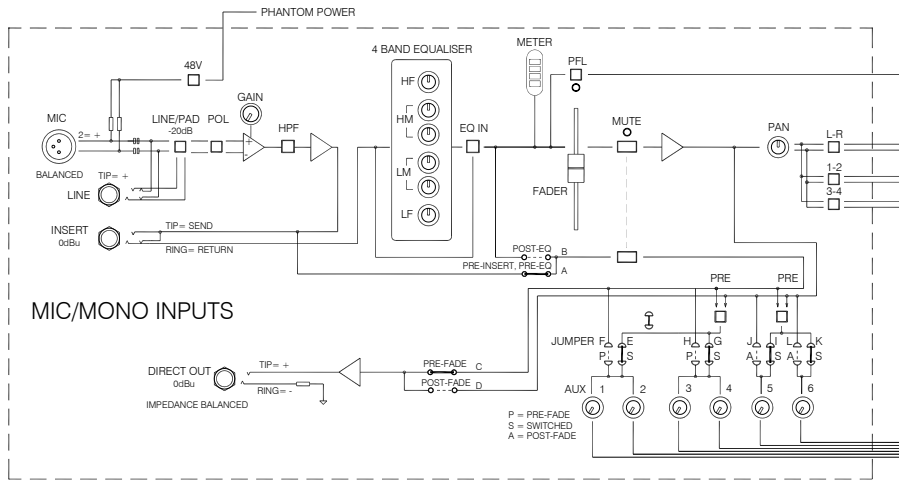

User Options

The **GL2400** has a versatile architecture which should satisfy most applications you may encounter without modification. However, the following internal options provide alternative settings for those applications that may demand them. Access is required to the internal assemblies. For user convenience, pluggable jumper links are used in most places.



Do not adjust the user options while power is applied to the console. Do not remove or tamper with the internal power unit, its cover or wiring.

Remove the base Switch off power and unplug all the cables. Invert the console on a flat, clean, well lit surface. Use Torx (star head) screwdrivers to remove the screws holding the base to the chassis. Use a T10 driver to remove the two M3x12mm screws holding the base to the underside of the internal power unit. Use a T15 driver to remove the set of 6Bx5/16 screws holding the base to the rear and underside of the chassis. Carefully lift off the base.

Configure the internal options Fit any options required referring to the instructions provided. Set the option jumpers to the required positions. Make sure they are pressed fully home. Check that all channels are correctly set and all options fitted according to their instructions. Make sure that no debris or parts are left loose inside the console.

Refit the base Carefully reposition the base. Refit the fixing screws.

IMPORTANT: Check carefully that all channel jumpers are correctly set as required. Errors on one or more channels now may cause user problems later. We recommend that you write the repositioned jumper settings on a label and adhere this to the rear panel. This would provide a helpful reference to other users of the console.

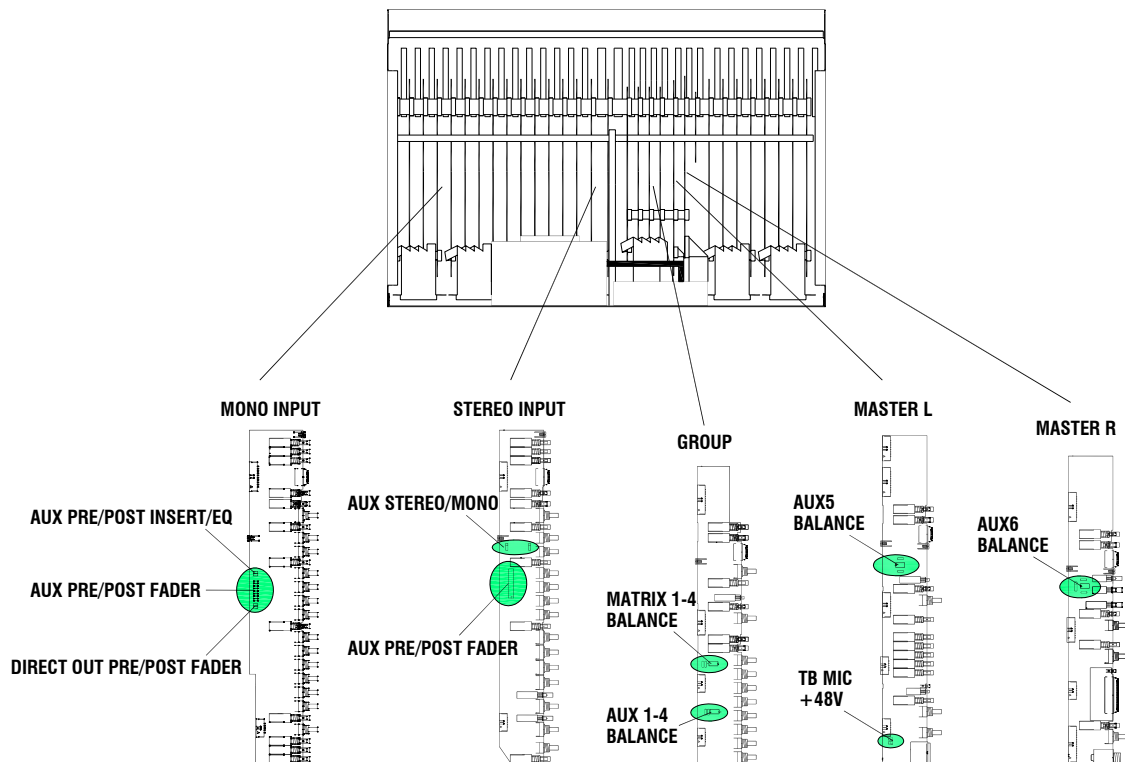

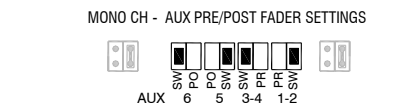
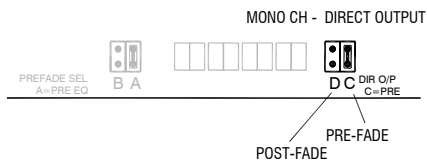
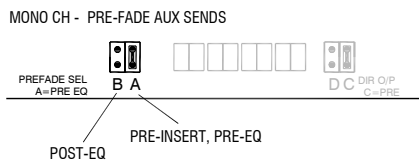

SW = PRE/POST SWITCH
 PR = PRE-FADE
 PO = POST-FADE

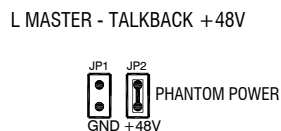
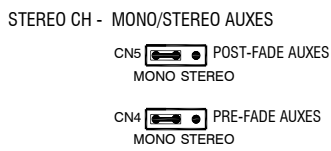
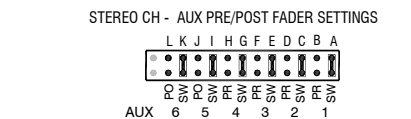

Aux pre/post EQ Factory default for the mono channel pre-fade auxes is pre-insert, pre-EQ. This is popular with many users mixing monitors from FOH. It prevents the channel EQ and inserted compressors affecting the monitor mix. Move the jumper from A to B to change this to post-insert, post-EQ if preferred, for example when using corrective EQ affecting FOH and monitors. Note that auxes are always post-mute.

Direct output source Factory default is pre-fader (as set for the pre-fade auxes). This is common for live recording to multitrack. The live mix fader movements do not affect the recording. Move the jumper from C to D to change to post-fade. Post-fade is appropriate when using the output as a direct channel effects send.

Channel Aux pre/post settings Factory default is Aux 1-4 = switched, Aux 5-6 = switched pre/post fader. You can change these settings for different combinations of permanent or switched pre/post fade auxes by repositioning the links. Note that these are solder links on the mono channels. Refer to the system block diagram to explore the possibilities. Make sure you set all mono and stereo channels the same. To avoid possible future confusion when the console is used by other operators, we recommend you only change these settings if absolutely necessary.

Stereo/Mono aux source The stereo channels feed the auxes with a mono sum of L+R. This can be changed so that L feeds the odd numbered auxes, and R the even. This may be preferred when using odd/even auxes as stereo pairs. Factory default is the mono setting.

Talkback mic +48V Factory default is +48V phantom power turned on for the front panel talkback mic XLR input. The option jumper is behind the TB mic XLR on the L Master board. If you prefer, phantom power can be disabled by repositioning the jumper to the GND position.

Note that phantom power should not harm non-powered dynamic microphones as long as balanced connections are used.

WARNING: Do not connect unbalanced sources or cables to inputs with phantom power selected. To avoid loud clicks do not press the TALK switch when plugging or unplugging the talkback microphone.

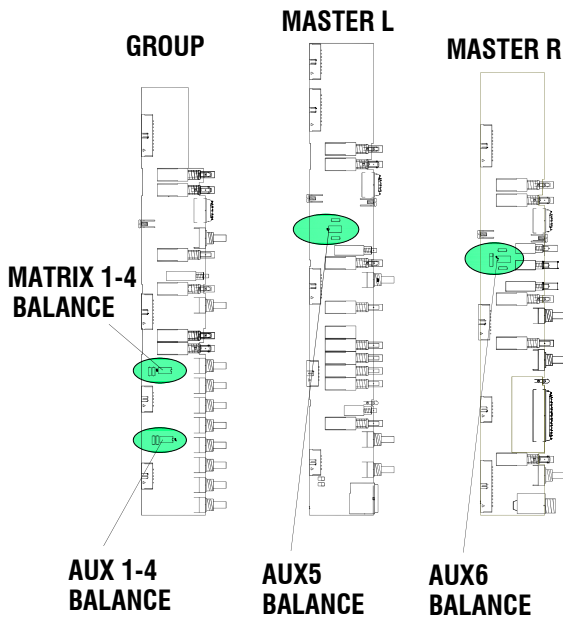

Output balance options The aux and matrix outputs are impedance balanced as standard operating at nominal -2dBu and with +20dBu maximum drive. They provide similar interference rejection to electronically balanced outputs when connected to balanced equipment inputs. An electronically balanced option is available if you require nominal +4dBu and higher output drive up to +26dBu over very long cable runs. However, it is not usually necessary to fit this option as the impedance balanced drive satisfies most applications. Check that you really need the option before fitting it.

There are two balanced driver ICs which may be used. Either is suitable. These are available from Allen & Heath or good electronic component suppliers. The Allen & Heath part number is shown below:

SSM2142P	A&H Part AE0302
DRV134	A&H Part AE5725

For each aux master, snip the legs of the two zero ohm resistor links next to the IC socket. This removes them from the circuit. Now simply plug the option IC into the socket. Observe the correct IC pin1 orientation and make sure its legs are correctly aligned with the socket. Test the output once the work is complete. You should measure the same level but opposite polarity signal between + (hot) and ground, and - (cold) and ground.

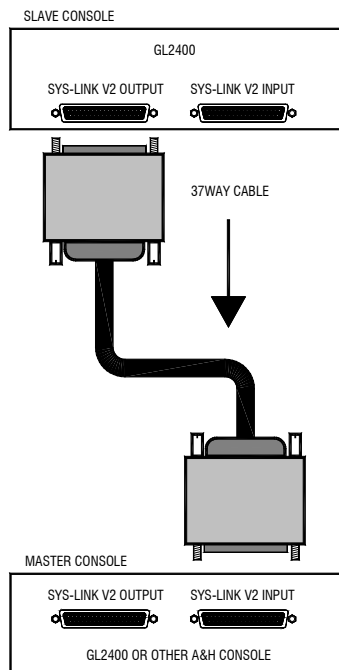

Sys-Link V2 input/output option A blank plate is fitted here as standard. This may be replaced with an optional card which provides the console inputs, outputs and PFL system on two 37way D connectors for linking to other Allen & Heath consoles already fitted with Sys-Link V2. The **GL2400** can become an input channel expander (slave) or have its number of input channels expanded (master) when linked to other consoles.

A 37way shielded multi-core cable carries the balanced mix signals and PFL/AFL system to or from the other console.

IMPORTANT: Note that you need a 37 to 25way adapter cable if you are connecting Sys-Link V2 (Version 2) to the older Sys-Link V1 (Version 1) standard.

For full details please refer to the Sys-Link option Applications Note AP6050 and Fitting Instructions AP6049.

Copy and use this page to record your console settings.

GL2400

EXT IN 1-4, GRP 1-4, L, R, LEVEL, MUTE, AFL, MTX 1-4

TALKBACK, MIC, PHONES, OSC/NOISE, ZTRK REPLAY, SELECT, L-R, GRP 1-4, AUX 1-2, AUX 3-4, AUX 5-6, MONITOR, TALK, L-R ZTRK

AUX 1-6, AFL, REV

PAN, M SOURCE, MODE

PFL/SIG, MUTE, AFL

GRP1-4, L, R, M, LISTEN

1234LRM

38

GL2400 User Guide

Copy and use this page to record your console settings.



<input type="checkbox"/> +48V <input type="checkbox"/> POLARITY <input type="checkbox"/> LINE (PAD) GAIN <input type="checkbox"/> HPF /700Hz	<input type="checkbox"/> +48V <input type="checkbox"/> POLARITY <input type="checkbox"/> LINE (PAD) GAIN <input type="checkbox"/> HPF /700Hz	<input type="checkbox"/> +48V <input type="checkbox"/> POLARITY <input type="checkbox"/> LINE (PAD) GAIN <input type="checkbox"/> HPF /700Hz	<input type="checkbox"/> +48V <input type="checkbox"/> POLARITY <input type="checkbox"/> LINE (PAD) GAIN <input type="checkbox"/> HPF /700Hz	<input type="checkbox"/> +48V <input type="checkbox"/> POLARITY <input type="checkbox"/> LINE (PAD) GAIN <input type="checkbox"/> HPF /700Hz	<input type="checkbox"/> +48V <input type="checkbox"/> POLARITY <input type="checkbox"/> LINE (PAD) GAIN <input type="checkbox"/> HPF /700Hz	<input type="checkbox"/> +48V <input type="checkbox"/> POLARITY <input type="checkbox"/> LINE (PAD) GAIN <input type="checkbox"/> HPF /700Hz	<input type="checkbox"/> +48V <input type="checkbox"/> POLARITY <input type="checkbox"/> LINE (PAD) GAIN <input type="checkbox"/> HPF /700Hz
HF 12k -15 3k +15 700 500Hz 15k 6k	HF 12k -15 3k +15 700 500Hz 15k 6k	HF 12k -15 3k +15 700 500Hz 15k 6k	HF 12k -15 3k +15 700 500Hz 15k 6k	HF 12k -15 3k +15 700 500Hz 15k 6k	HF 12k -15 3k +15 700 500Hz 15k 6k	HF 12k -15 3k +15 700 500Hz 15k 6k	HF 12k -15 3k +15 700 500Hz 15k 6k
HM -15 180 +15 70 190 250 45 35Hz 1k 400	HM -15 180 +15 70 190 250 45 35Hz 1k 400	HM -15 180 +15 70 190 250 45 35Hz 1k 400	HM -15 180 +15 70 190 250 45 35Hz 1k 400	HM -15 180 +15 70 190 250 45 35Hz 1k 400	HM -15 180 +15 70 190 250 45 35Hz 1k 400	HM -15 180 +15 70 190 250 45 35Hz 1k 400	HM -15 180 +15 70 190 250 45 35Hz 1k 400
LM -15 180 +15 70 190 250 45 35Hz 1k 400	LM -15 180 +15 70 190 250 45 35Hz 1k 400	LM -15 180 +15 70 190 250 45 35Hz 1k 400	LM -15 180 +15 70 190 250 45 35Hz 1k 400	LM -15 180 +15 70 190 250 45 35Hz 1k 400	LM -15 180 +15 70 190 250 45 35Hz 1k 400	LM -15 180 +15 70 190 250 45 35Hz 1k 400	LM -15 180 +15 70 190 250 45 35Hz 1k 400
LF 80Hz -15 +15	LF 80Hz -15 +15	LF 80Hz -15 +15	LF 80Hz -15 +15	LF 80Hz -15 +15	LF 80Hz -15 +15	LF 80Hz -15 +15	LF 80Hz -15 +15
<input type="checkbox"/> EQ IN	<input type="checkbox"/> EQ IN	<input type="checkbox"/> EQ IN	<input type="checkbox"/> EQ IN	<input type="checkbox"/> EQ IN	<input type="checkbox"/> EQ IN	<input type="checkbox"/> EQ IN	<input type="checkbox"/> EQ IN
AUX 1 +6	AUX 1 +6	AUX 1 +6	AUX 1 +6	AUX 1 +6	AUX 1 +6	AUX 1 +6	AUX 1 +6
AUX 2 +6	AUX 2 +6	AUX 2 +6	AUX 2 +6	AUX 2 +6	AUX 2 +6	AUX 2 +6	AUX 2 +6
AUX 3 +6	AUX 3 +6	AUX 3 +6	AUX 3 +6	AUX 3 +6	AUX 3 +6	AUX 3 +6	AUX 3 +6
AUX 4 +6	AUX 4 +6	AUX 4 +6	AUX 4 +6	AUX 4 +6	AUX 4 +6	AUX 4 +6	AUX 4 +6
<input type="checkbox"/> POST <input type="checkbox"/> PRE	<input type="checkbox"/> POST <input type="checkbox"/> PRE	<input type="checkbox"/> POST <input type="checkbox"/> PRE	<input type="checkbox"/> POST <input type="checkbox"/> PRE	<input type="checkbox"/> POST <input type="checkbox"/> PRE	<input type="checkbox"/> POST <input type="checkbox"/> PRE	<input type="checkbox"/> POST <input type="checkbox"/> PRE	<input type="checkbox"/> POST <input type="checkbox"/> PRE
AUX 5 +6	AUX 5 +6	AUX 5 +6	AUX 5 +6	AUX 5 +6	AUX 5 +6	AUX 5 +6	AUX 5 +6
AUX 6 +6	AUX 6 +6	AUX 6 +6	AUX 6 +6	AUX 6 +6	AUX 6 +6	AUX 6 +6	AUX 6 +6
<input type="checkbox"/> POST <input type="checkbox"/> PRE	<input type="checkbox"/> POST <input type="checkbox"/> PRE	<input type="checkbox"/> POST <input type="checkbox"/> PRE	<input type="checkbox"/> POST <input type="checkbox"/> PRE	<input type="checkbox"/> POST <input type="checkbox"/> PRE	<input type="checkbox"/> POST <input type="checkbox"/> PRE	<input type="checkbox"/> POST <input type="checkbox"/> PRE	<input type="checkbox"/> POST <input type="checkbox"/> PRE
PAN 000 EVEN	PAN 000 EVEN	PAN 000 EVEN	PAN 000 EVEN	PAN 000 EVEN	PAN 000 EVEN	PAN 000 EVEN	PAN 000 EVEN
<input type="checkbox"/> MUTE	<input type="checkbox"/> MUTE	<input type="checkbox"/> MUTE	<input type="checkbox"/> MUTE	<input type="checkbox"/> MUTE	<input type="checkbox"/> MUTE	<input type="checkbox"/> MUTE	<input type="checkbox"/> MUTE
PFL PKI +6 0 SIG 10 5	PFL PKI +6 0 SIG 10 5	PFL PKI +6 0 SIG 10 5	PFL PKI +6 0 SIG 10 5	PFL PKI +6 0 SIG 10 5	PFL PKI +6 0 SIG 10 5	PFL PKI +6 0 SIG 10 5	PFL PKI +6 0 SIG 10 5
L-R 0 5 10	L-R 0 5 10	L-R 0 5 10	L-R 0 5 10	L-R 0 5 10	L-R 0 5 10	L-R 0 5 10	L-R 0 5 10
1-2 5 10	1-2 5 10	1-2 5 10	1-2 5 10	1-2 5 10	1-2 5 10	1-2 5 10	1-2 5 10
3-4 10 20	3-4 10 20	3-4 10 20	3-4 10 20	3-4 10 20	3-4 10 20	3-4 10 20	3-4 10 20
20 30 00	20 30 00	20 30 00	20 30 00	20 30 00	20 30 00	20 30 00	20 30 00

Copy and use this page to record your console settings.



<input type="checkbox"/> +48V <input type="checkbox"/> POLARITY <input type="checkbox"/> LINE (PAD) GAIN <input type="checkbox"/> HPF /70Hz	<input type="checkbox"/> +48V <input type="checkbox"/> POLARITY <input type="checkbox"/> LINE (PAD) GAIN <input type="checkbox"/> HPF /70Hz	<input type="checkbox"/> +48V <input type="checkbox"/> POLARITY <input type="checkbox"/> LINE (PAD) GAIN <input type="checkbox"/> HPF /70Hz	<input type="checkbox"/> +48V <input type="checkbox"/> POLARITY <input type="checkbox"/> LINE (PAD) GAIN <input type="checkbox"/> HPF /70Hz	<input type="checkbox"/> +48V <input type="checkbox"/> POLARITY <input type="checkbox"/> LINE (PAD) GAIN <input type="checkbox"/> HPF /70Hz	<input type="checkbox"/> +48V <input type="checkbox"/> POLARITY <input type="checkbox"/> LINE (PAD) GAIN <input type="checkbox"/> HPF /70Hz	<input type="checkbox"/> +48V <input type="checkbox"/> POLARITY <input type="checkbox"/> LINE (PAD) GAIN <input type="checkbox"/> HPF /70Hz	<input type="checkbox"/> +48V <input type="checkbox"/> POLARITY <input type="checkbox"/> LINE (PAD) GAIN <input type="checkbox"/> HPF /70Hz
HF 12k -15 3k +15 700 500Hz 6k HM -15 180 250 45 35Hz 1k LM -15 15 80Hz	HF 12k -15 3k +15 700 500Hz 6k HM -15 180 250 45 35Hz 1k LM -15 15 80Hz	HF 12k -15 3k +15 700 500Hz 6k HM -15 180 250 45 35Hz 1k LM -15 15 80Hz	HF 12k -15 3k +15 700 500Hz 6k HM -15 180 250 45 35Hz 1k LM -15 15 80Hz	HF 12k -15 3k +15 700 500Hz 6k HM -15 180 250 45 35Hz 1k LM -15 15 80Hz	HF 12k -15 3k +15 700 500Hz 6k HM -15 180 250 45 35Hz 1k LM -15 15 80Hz	HF 12k -15 3k +15 700 500Hz 6k HM -15 180 250 45 35Hz 1k LM -15 15 80Hz	HF 12k -15 3k +15 700 500Hz 6k HM -15 180 250 45 35Hz 1k LM -15 15 80Hz
AUX 1 AUX 2 AUX 3 AUX 4 AUX 5 AUX 6 <input type="checkbox"/> POST <input type="checkbox"/> PRE	AUX 1 AUX 2 AUX 3 AUX 4 AUX 5 AUX 6 <input type="checkbox"/> POST <input type="checkbox"/> PRE	AUX 1 AUX 2 AUX 3 AUX 4 AUX 5 AUX 6 <input type="checkbox"/> POST <input type="checkbox"/> PRE	AUX 1 AUX 2 AUX 3 AUX 4 AUX 5 AUX 6 <input type="checkbox"/> POST <input type="checkbox"/> PRE	AUX 1 AUX 2 AUX 3 AUX 4 AUX 5 AUX 6 <input type="checkbox"/> POST <input type="checkbox"/> PRE	AUX 1 AUX 2 AUX 3 AUX 4 AUX 5 AUX 6 <input type="checkbox"/> POST <input type="checkbox"/> PRE	AUX 1 AUX 2 AUX 3 AUX 4 AUX 5 AUX 6 <input type="checkbox"/> POST <input type="checkbox"/> PRE	AUX 1 AUX 2 AUX 3 AUX 4 AUX 5 AUX 6 <input type="checkbox"/> POST <input type="checkbox"/> PRE
PAN L R 000 EVEN <input type="checkbox"/> MUTE	PAN L R 000 EVEN <input type="checkbox"/> MUTE	PAN L R 000 EVEN <input type="checkbox"/> MUTE	PAN L R 000 EVEN <input type="checkbox"/> MUTE	PAN L R 000 EVEN <input type="checkbox"/> MUTE	PAN L R 000 EVEN <input type="checkbox"/> MUTE	PAN L R 000 EVEN <input type="checkbox"/> MUTE	PAN L R 000 EVEN <input type="checkbox"/> MUTE
PFL PKI +6 0 SIG 10 5 L-R 1-2 3-4 20 30 00	PFL PKI +6 0 SIG 10 5 L-R 1-2 3-4 20 30 00	PFL PKI +6 0 SIG 10 5 L-R 1-2 3-4 20 30 00	PFL PKI +6 0 SIG 10 5 L-R 1-2 3-4 20 30 00	PFL PKI +6 0 SIG 10 5 L-R 1-2 3-4 20 30 00	PFL PKI +6 0 SIG 10 5 L-R 1-2 3-4 20 30 00	PFL PKI +6 0 SIG 10 5 L-R 1-2 3-4 20 30 00	PFL PKI +6 0 SIG 10 5 L-R 1-2 3-4 20 30 00